



LSM: Overview and Applications

Shankar Vemulapalli
Yogi Raghunathan

Agenda

- Need for Label Switched Multicast
- Solutions
 - mLDP
 - p2mp TE
- LSM Applications
 - PIM SSM Transit for IPv4/IPv6
 - mVPN Deployments (Default/Data)
 - Video Contribution & Distribution
- LSM Case Study
- LSM Deployment Considerations

Scope of the Presentation

- Presentation is going to cover the motivations for the Label Switched Multicast
- Goes over the building blocks of how both mLDP and P2MP-TE LSPs are set up
- Look at the applications of the LSM
- LSM Deployment Considerations
- Focus is more on the MPLS Core

What is LSM

- Label Switched Multicast

MPLS Technology extensions to support multicast using Labels

- ✓ Point-to-Multipoint LSPs
- ✓ Multipoint-to-Multipoint LSPs

- Multicast Label Switched Paths

Trees built using Labels

- Native Multicast Mapped onto Multicast LSPs

Drivers for LSM

- Customers want to leverage their MPLS infrastructure for transporting IP Multicast, so common data plane for unicast and multicast
- Service Providers asking for a tighter integration of Multicast with MPLS Traffic Engineering and GMPLS for their Triple Play Services
- Unify forwarding between VPN Unicast & Multicast for operational reasons in customer spaces using native MPLS/VPN.
- Simplification of Core Routers by removing PIM

Drivers for LSM

- Drivers for point-to-multipoint from Video Transport
 - ✓ Contribution
 - Point-to-Multipoint Video feeds, e.g, sports events to multiple broadcasters
 - Desire to have Video quality probes at each network hop for service assurance and monitoring
 - Source Feed to Production Houses

 - ✓ Distribution
 - Implicitly required for IPTV BW Efficiency
 - Video content from Studio to Distribution Center
 - Video Content to the end users

Work at the Standards

- Standardization work is happening at IETF for both LDP and RSVP signaling protocols to carry labels for the multicast along with extensions for OAM

mLDP	
LDP Extensions to P2MP& MP2MP LSPs	draft-ietf-mpls-ldp-p2mp
LDP Capabilities	RFC 5561
In-Band Signaling	draft-ietf-mpls-mldp-in-band-signaling

P2MP TE	
Signaling Req. for P2MP-TE LSPs	RFC 4461
Extensions to RSVP	RFC 4875

LSM OAM	
P2MP LSP Extensions for LSP-Ping	draft-ietf-mpls-p2mp-lsp-ping
Proxy LSP Ping	draft-ietf-mpls-remote-lsp-ping
Connectivity Verification for Multicast LSPs	draft-ietf-mpls-mcast-cv

VPLS	
LSM Support for VPLS	RFC 5501

LSM Signaling Options

	Multicast LDP	P2MP RSVP TE
Characteristics	<ul style="list-style-type: none">• LDP signaling extensions• Receiver-initiated LSP tree building• Dynamic IGP-based LSP tree building	<ul style="list-style-type: none">• RSVP signaling extensions• Source-initiated LSP tree building• Static/deterministic LSP tree building
Applicability and Drivers	<ul style="list-style-type: none">• Dynamic IP multicast receivers (and sources)• Fast ReRoute protection of IP multicast traffic• Simplified control plane (i.e., LDP instead of PIM)• Common MPLS forwarding plane for unicast and multicast	<ul style="list-style-type: none">• Moderate number of static IP multicast receivers• Fast ReRoute protection of IP multicast traffic• Traffic engineering of IP multicast traffic (constraint-based routing, bandwidth admission control)

LSM Architecture

- LSM architecture supports a range of services or “clients”
Over mLDP and P2MP TE control planes

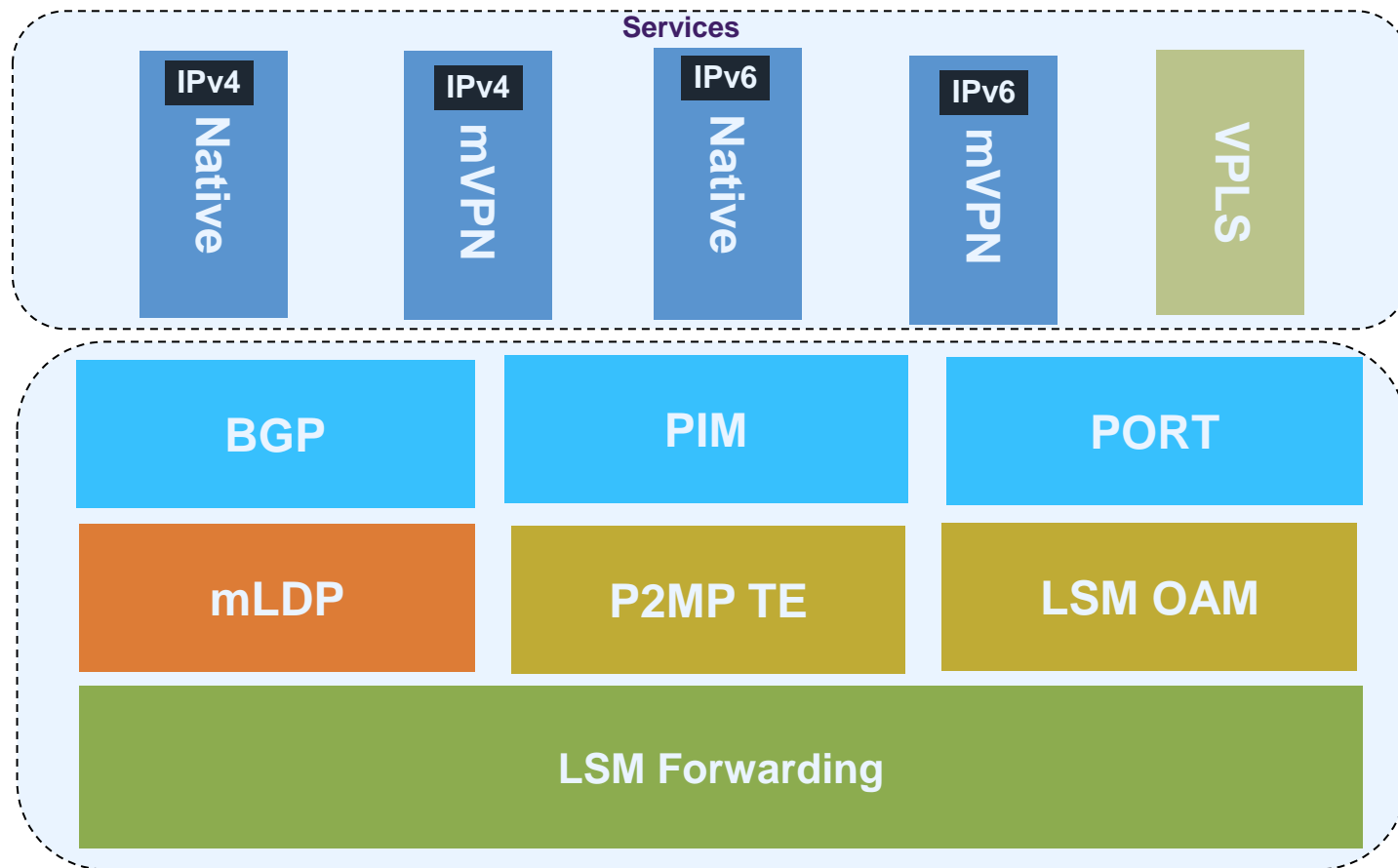

Terminology

Terminology	Description
LSR	Label Switch Router
Ingress LSR	Router acting as a Sender of an LSP & is closest to multicast source (Root Node)
Egress LSR	Router acting as a Receiver of an LSP & is closest to the multicast receiver (Leaf Node)
P2P LSP	LSP with one Unique Ingress LSR & one Unique Egress LSR
P2MP LSP	LSP with one Unique Ingress LSR & one or more Egress LSRs
MP2MP LSP	LSP that has one or more Leaf LSRs acting as Ingress or Egress
MP LSP	Any type of Multipoint LSP

Terminology

Terminology	Description
P2MP Tree	The ordered set of LSRs & links that comprise the path of a P2MP LSP from its Ingress LSR to all of its Egress LSRs
Upstream	Direction of the Multicast packet received from (from Egress towards Ingress)
Downstream	Direction of the Multicast packet sent to (from Ingress towards Egress)
Branch LSR	LSR of a P2MP or MP2MP LSP that has more than ONE downstream LSR
Bud LSR	LSR of P2MP or MP2MP LSP that is an Egress but also has one or more directly connected downstream LSR(s)
Leaf LSR	Egress LSR of a P2MP or Ingress/Egress LSR of a MP2MP LSP

Terminology Mapping

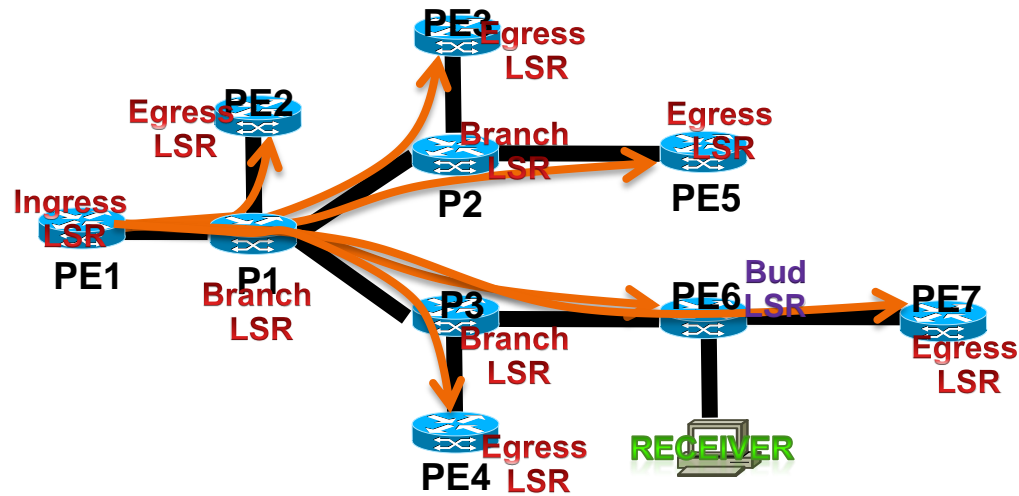
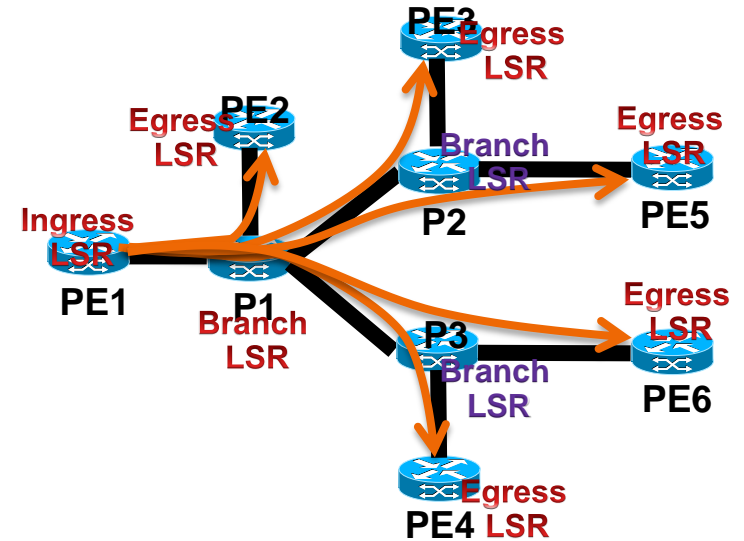
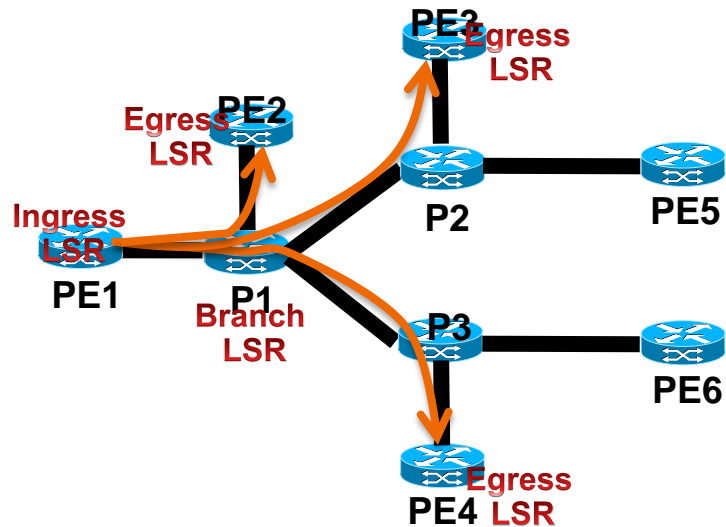

→ P2MP LSP

mLDP

mLDP

- Receiver driven (Egress LSR) MP LSP Setup
 - Labels are distributed from the Leaves towards the Root
- MP LSP Path Selection is based on Root Address
 - Derived from BGP NH of Source or Statically Configured
 - Supports P2MP & MP2MP Tree Construction
- Downstream on demand label allocation
 - Labels are not allocated unless there is a receiver interested
- Architecture supports In-Band & Out-of-Band signaling
- No PHP – The top label is used to identify tree

mLDP Topology

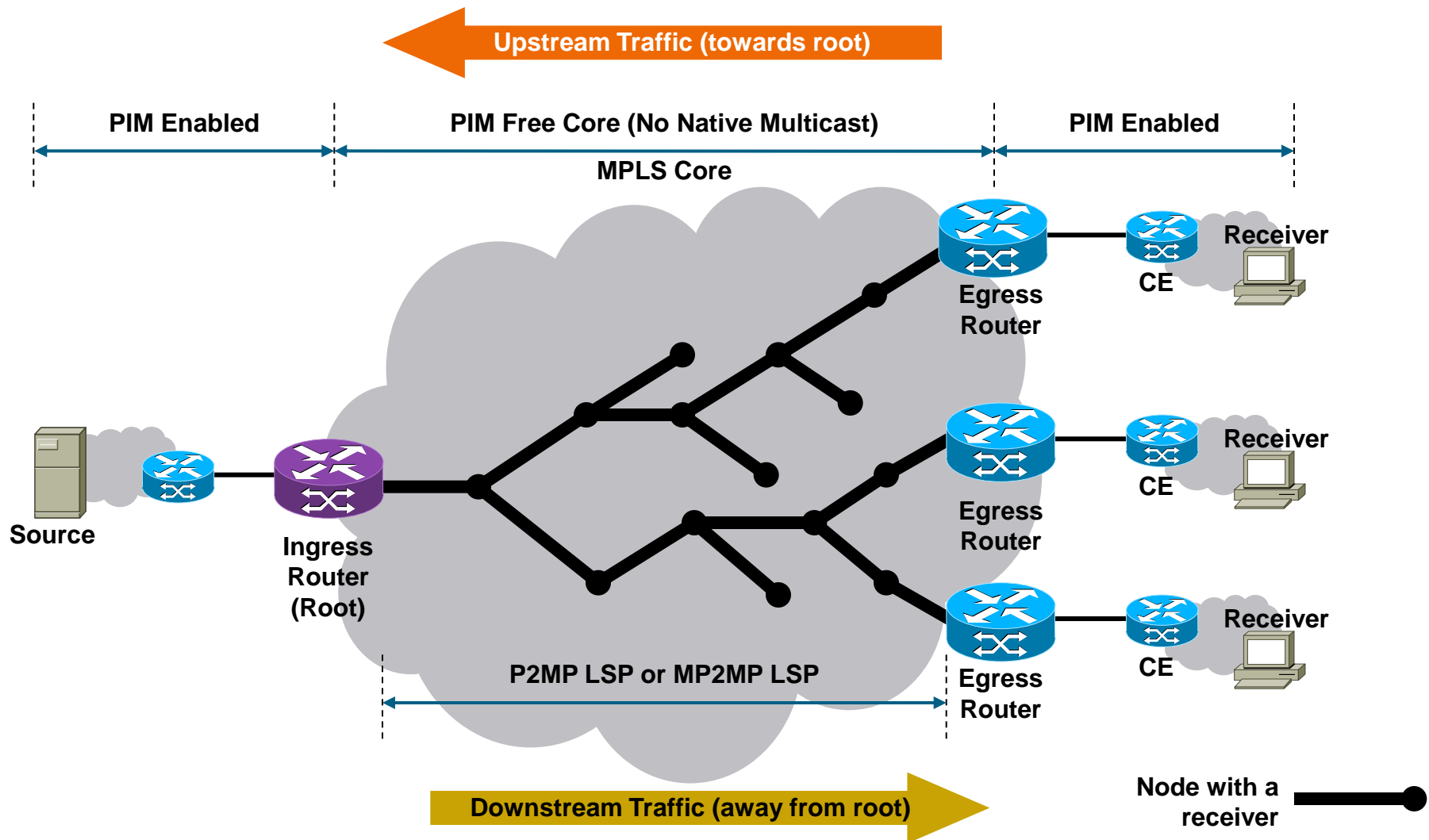

mLDP – LDP Extensions

- A P2MP Capability TLV is defined which will be carried in the Capabilities Parameter as part of the INITIALIZATION Message



New mLDP Capabilities

New Capabilities	Value
P2MP Capability	0x0508
MP2MP Capability	0x0509
MBB Capability	0x050A

mLDP – LDP Extensions

- A new P2MP FEC Element will be advertised as part of the FEC TLV in the Label Mapping message

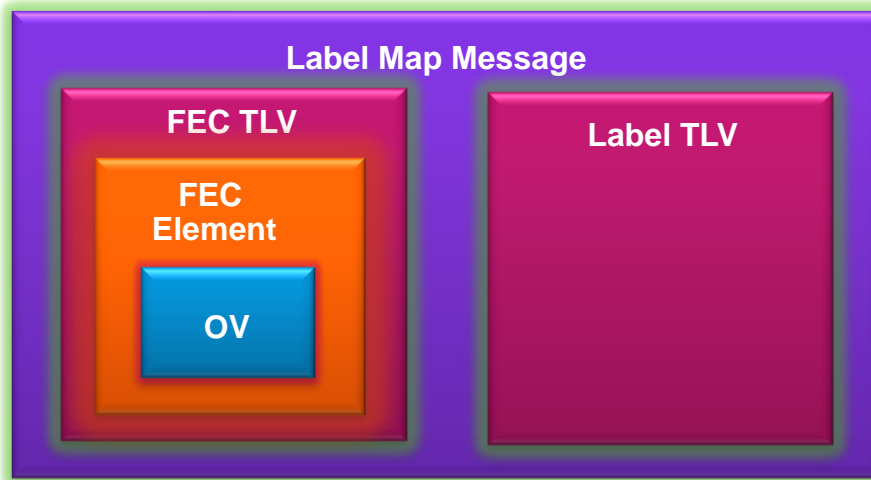

New LDP FEC Element Types

FEC Element Types	Value
P2MP FEC Type	0x06
MP2MP-UP FEC Type	0x07
MP2MP-Down FEC Type	0x08

mLDP – FEC Element

- P2MP FEC Element
- Consists of the Address of the Root of the P2MP LSP and Opaque Value
- Opaque Value consists of one or more LDP MP Opaque value Elements
- The Opaque Value is unique within the context of the Root Node.
- The combination uniquely identifies a P2MP LSP within the MPLS Network
 - Root Node Address
 - Opaque Value

mLDP – FEC Element

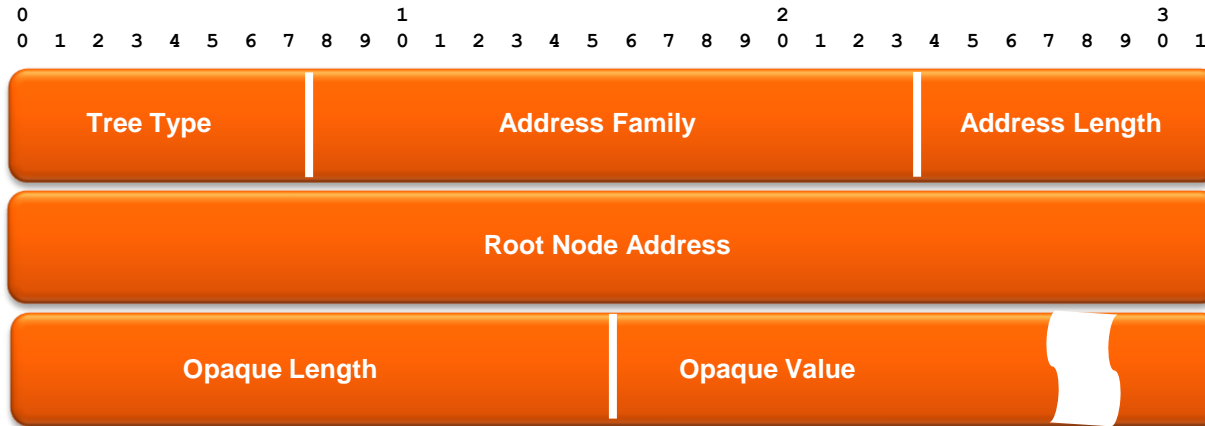

Parameters	Description
Tree Type	P2MP, MP2MP Up, MP2MP Down
Address Family	Root node address format (IPv4 =1 or IPv6 = 2)
Address Length	Number of octets in Root Address (IPv4 = 4, IPv6 = 16)
Root Node Address	Host address of MP LSP Root (within MPLS core)
Opaque Value	One or more TLVs uniquely identifying MP LSP within the in context of the root

mLDP – Root Node Address

- Root Address is selected by the Egress Router
 - Automatically derived from BGP next-hop or statically configured
- Root address is used to build the MP LSP
- Each router in the path does a routing table lookup on the root to discover the next-hop.
 - Label mapping message then sent to that next-hop
- Resulting in a dynamically created MP LSP
 - No pre-computed, traffic engineered path

mLDP – Opaque Value Element

- Opaque Value Element
- Each MP LSP is identified by unique opaque value which is used to uniquely identify the MP LSP
- Carries information that is meaningful to Ingress LSRs and Leaf LSRs but need not be interpreted by Transit LSRs
- It can represent the (S, G) stream (PIM-SSM Transit) or can be an LSP Identifier to define the Default/Data MDTs in an mVPN application

mLDP – Opaque Value

- 4 Multicast Applications are supported with each with its own Opaque Value

Applications	Description
IPv4 PIM-SSM Transit	Allows Global PIM-SSM Streams to be transported across the MPLS-Core. The Opaque Value contains the actual (S,G) which resides in the Global (mroute) table of the Ingress & Egress PE Routers
IPv6 PIM-SSM Transit	Same as Above but for IPv6
Multicast VPN	VPNv4 Traffic to be transported across Default-MDT (MI-PMSI) or Data-MDT (S-PMSI)
Direct-MDT or VPNv4 Transit	Allows VPNv4 streams to be directly built without the need for the Default-MDT to exist

mLDP - Signaling

- mLDP Signaling provides TWO Functions:
 - To Discover the FEC & its associated Opaque Value for a MP LSP
 - To assign a multicast flow to a MP LSP
- mLDP uses two signalling methods:
- In-Band Signaling
 - All egress routers use the same algorithm to construct the opaque value based on the multicast stream they want to join.
 - That may include, Source, Group, RD, next-hop...
 - Egress routers interested in the same multicast stream will create the same FEC.
 - Ingress PE multicast component parses the FEC and knows what multicast stream to forward.
- Out-of-Band Signaling
 - Opaque value is assigned by the ingress Root PE.
 - Egress PE's use an out-of-band signaling protocol to request the opaque value that belongs to a multicast stream.
 - Egress routers use the opaque value to construct the FEC and build the tree.
 - Allows for aggregating multicast streams on a single MP-T.

mLDP – In-Band Signaling Operation

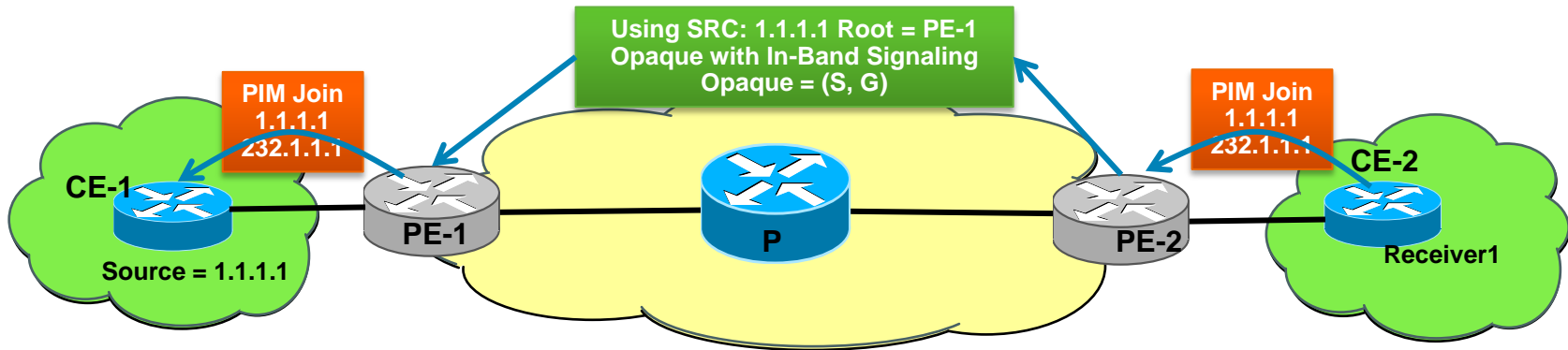

mLDP – Out-of-Band Signaling

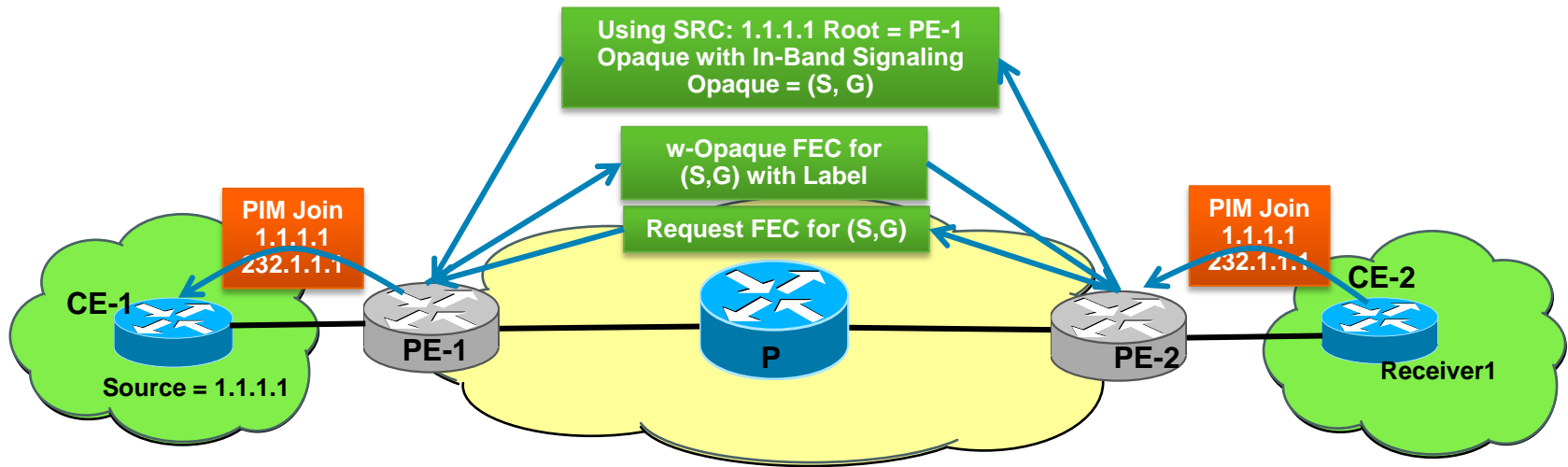

P2MP Basic Operation

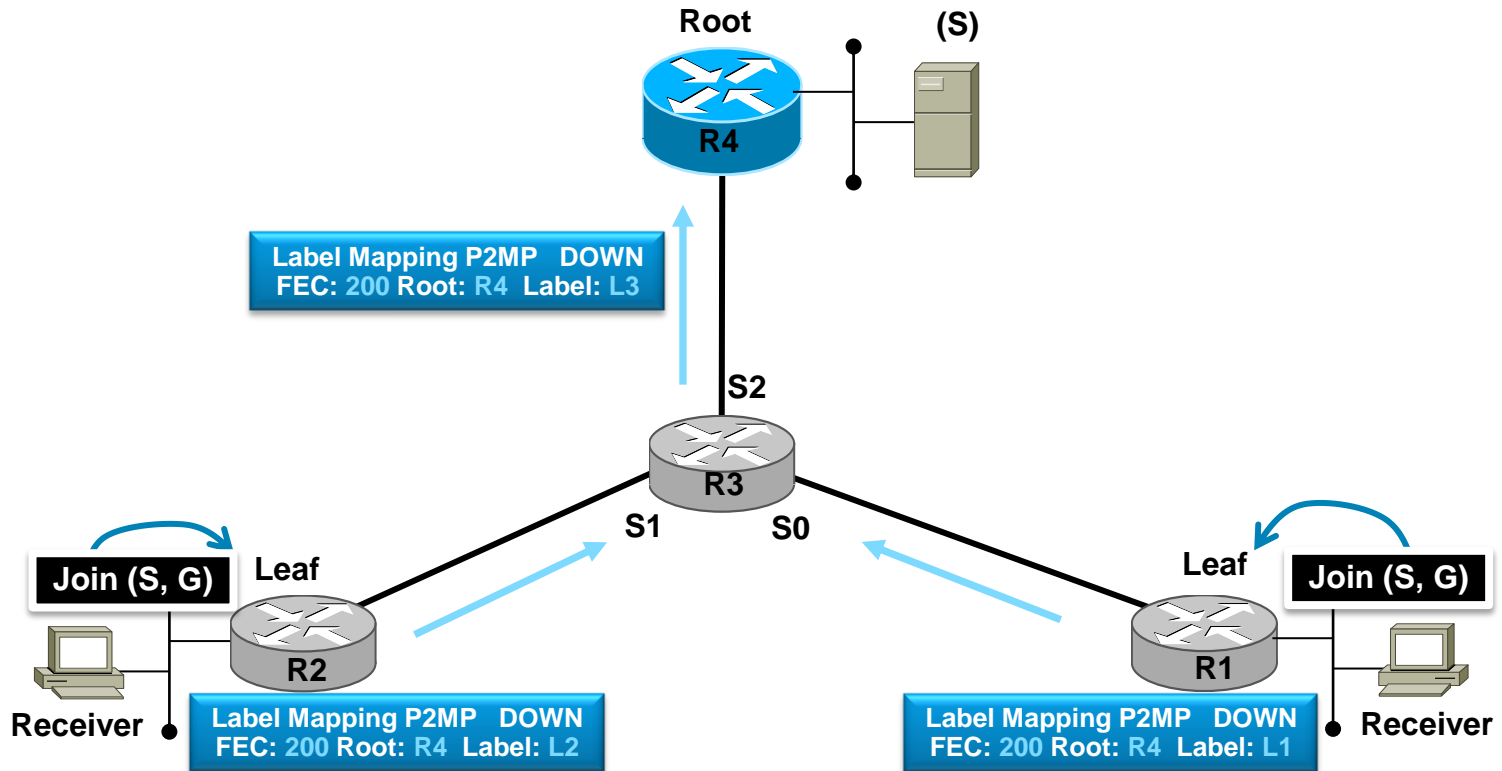

P2MP Basic Operation

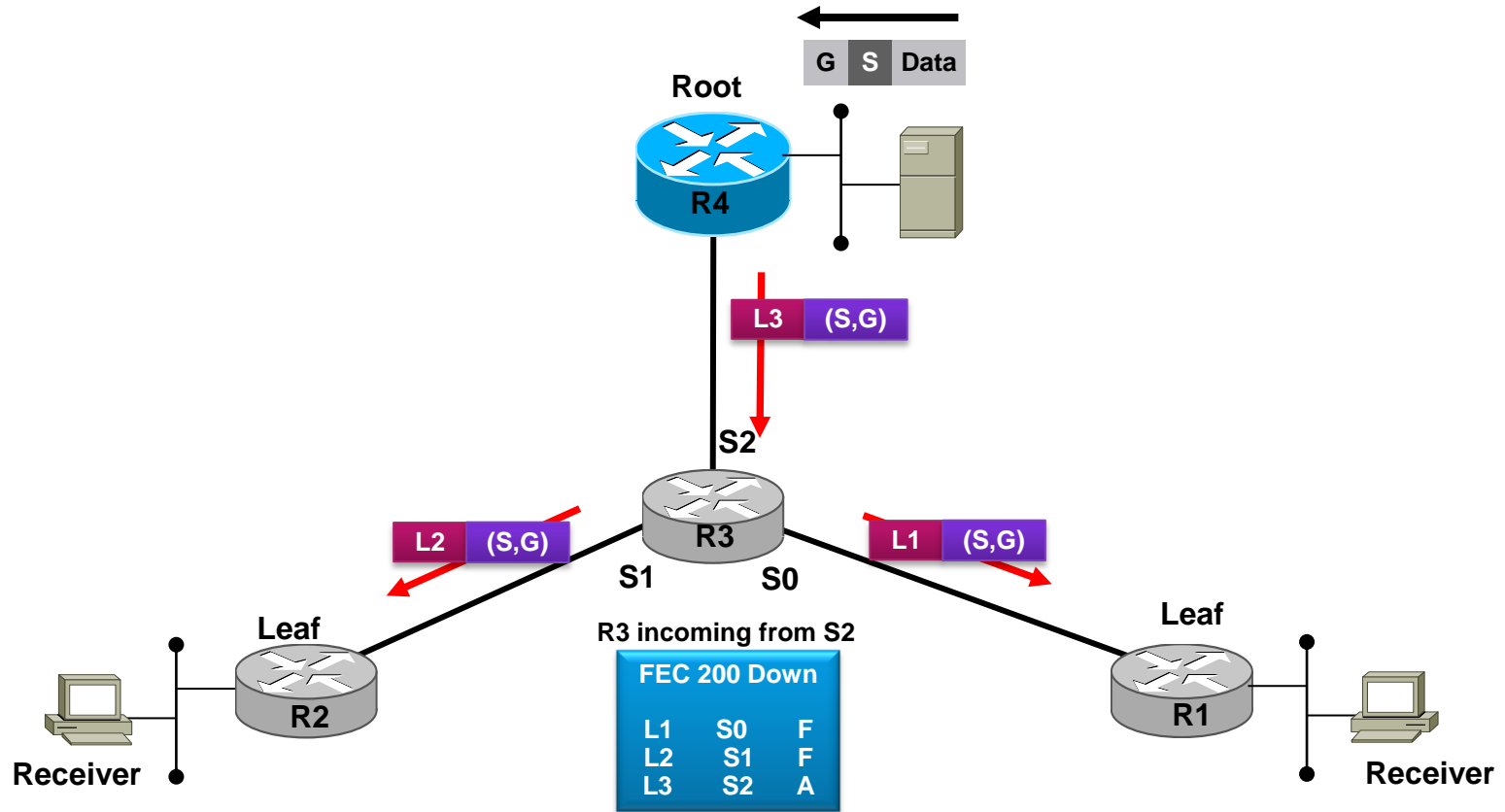

MP2MP Basic Operation

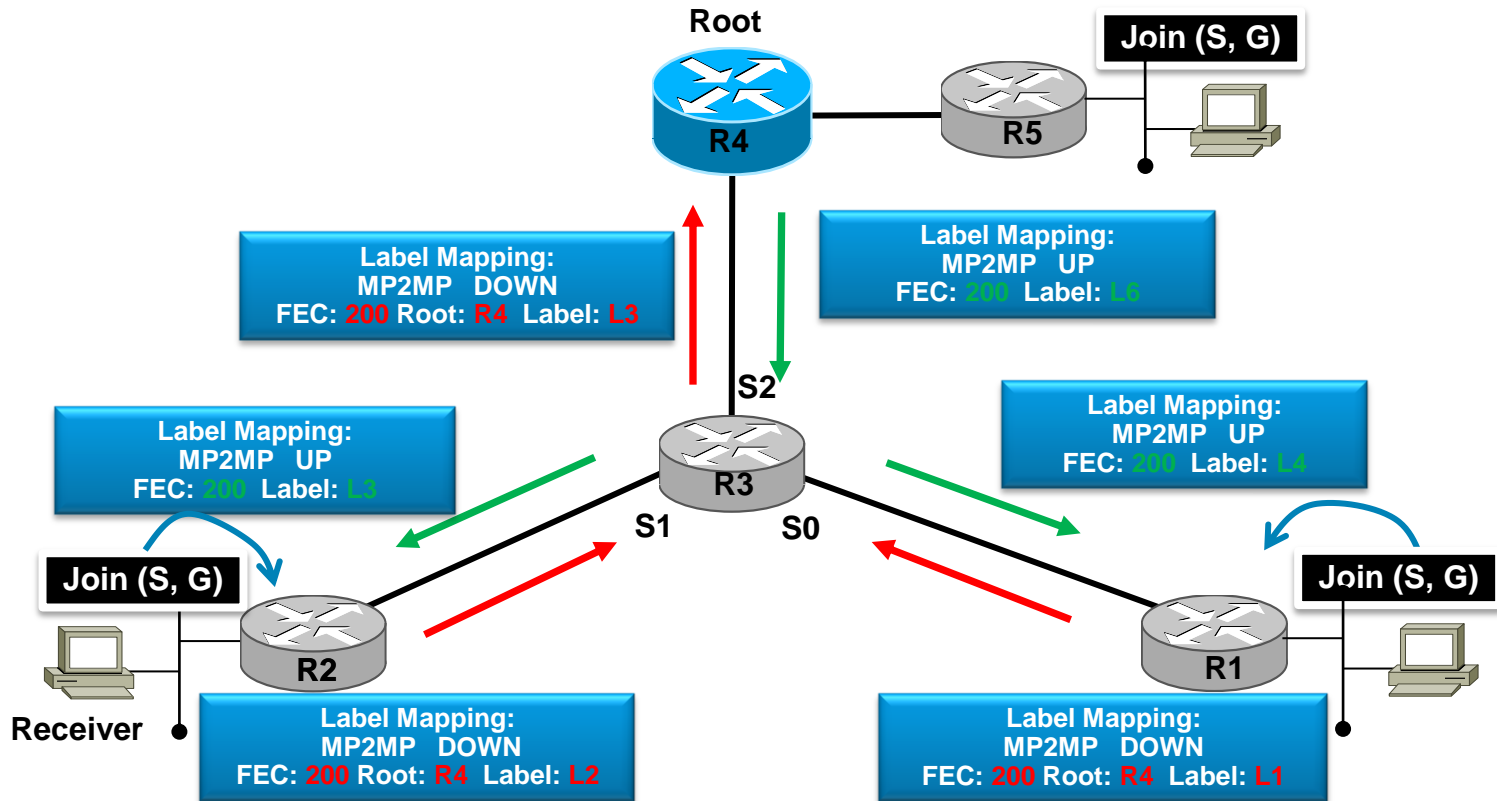

MP2MP Basic Operation

Look at R3: Downstream Label Replication Table from S2

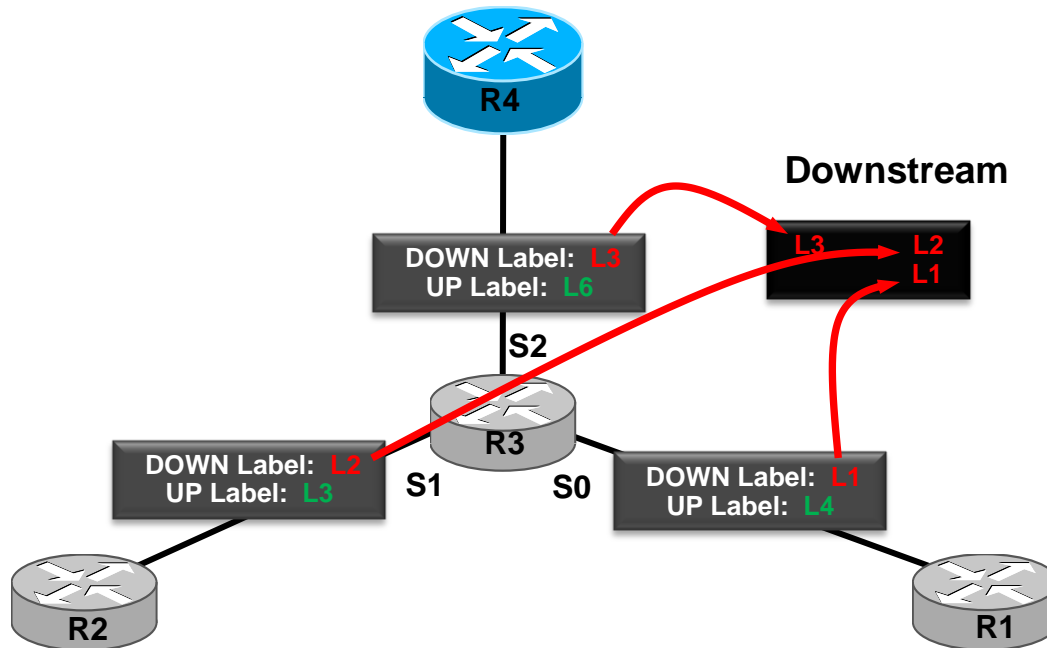

MP2MP Basic Operation

Look at R3 Upstream Label Replication Table from S1

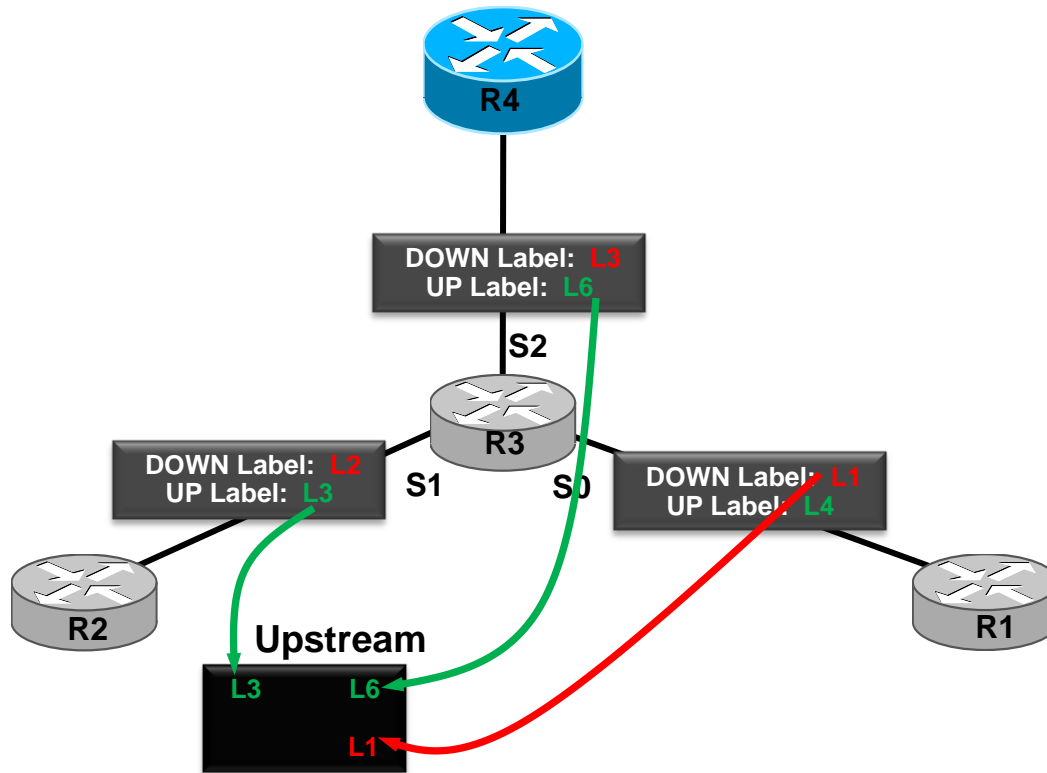

MP2MP Basic Operation

Look at R3 Upstream Label Replication Table from S0

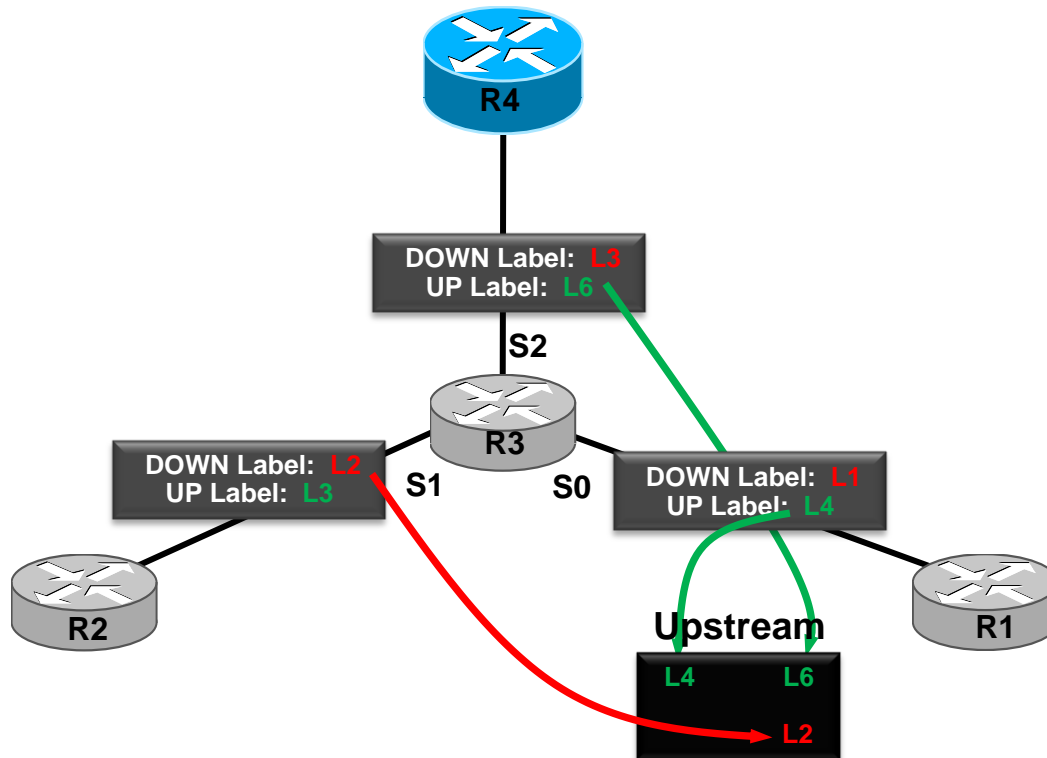

P2MP TE

P2MP TE

- Extensions to RSVP-TE Protocol are defined via RFC 4875 to support P2MP TE LSPs
- P2MP TE LSP is initiated by the Ingress LSR towards the Egress LSRs
- Supports only P2MP LSPs
- Support Traffic Engineering
 - Explicit Routing
 - Fast ReRoute
 - BW Reservation

Terminology

Common Terms are covered earlier as part of the Introduction.

Ingress LSR Egress LSR P2P LSP P2MP LSP Upstream
 Downstream Branch LSR Bud LSR Leaf LSR

Terminology	Description
Sub-LSP	A segment of a P2MP TE LSP that runs from one of the LSP's LSRs to one or more of its other LSRs
S2L Sub-LSP	Source to Leaf: A segment of a P2MP TE LSP that runs from HE to one Destination
Grafting	The operation of adding egress LSR(s) to an existing P2MP LSP
Pruning	An action where Egress LSR is removed from the P2MP LSP
Crossover	Crossover happens at an intersecting node when two or more incoming Sub-LSPs, belonging to the same LSP, have different input & different output interfaces
Remerge	Remerge happens at an intersecting node when two datastream belonging to the same P2MP LSP Merge into one datastream on output

Extensions to RSVP for P2MP TE

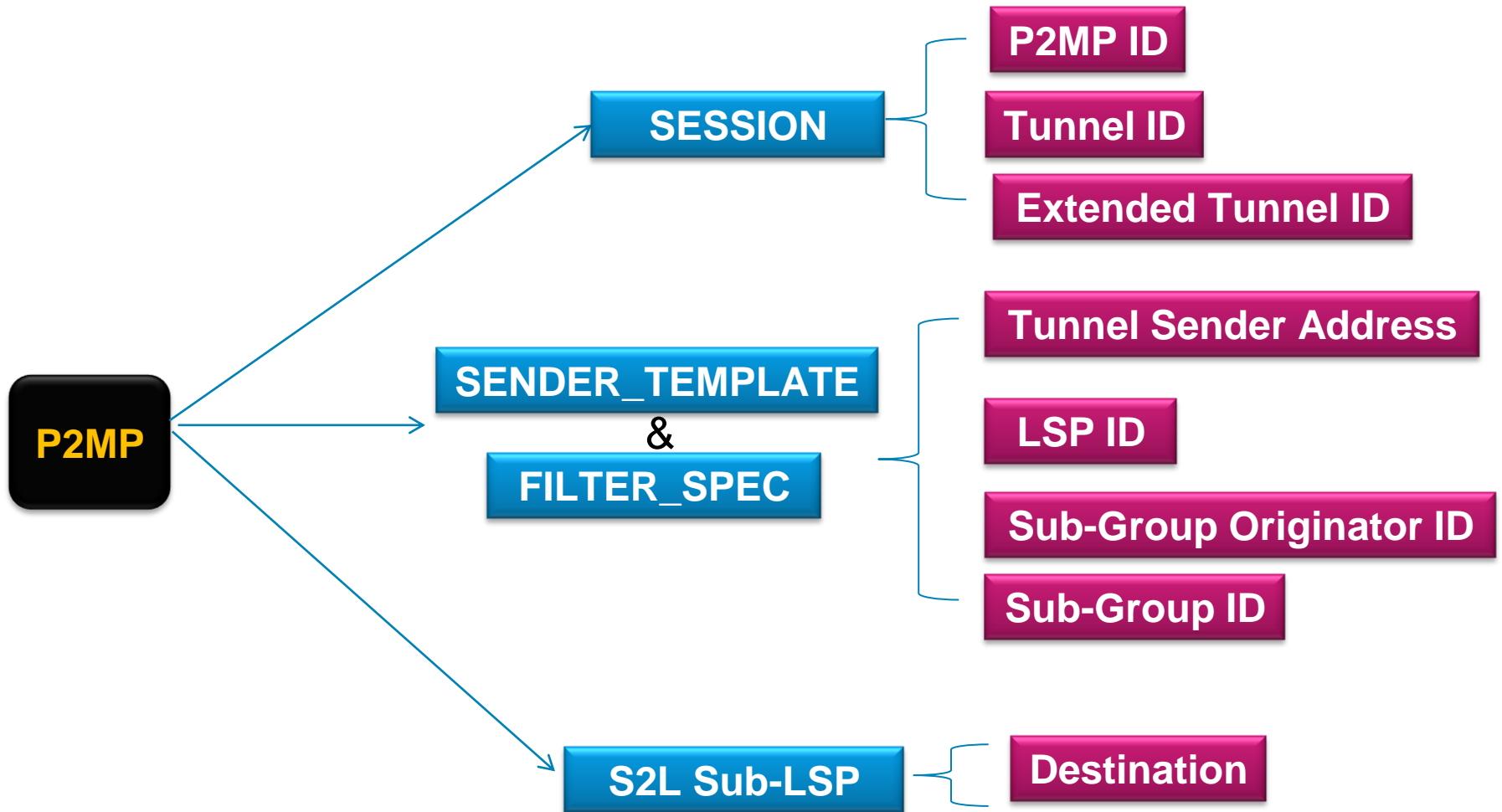

P2MP TE LSP

- It is ONE or MORE S2L Sub-LSPs
- It is a collection of all Sub-LSPs forms the P2MP LSP
- All Sub-LSPs belonging to the same P2MP LSP should share labels and resources when they share links
 - Share labels to prevent multiple copies of the same data being sent
- Identified by 5-Tuple Key



P2MP TE : Sub-LSPs

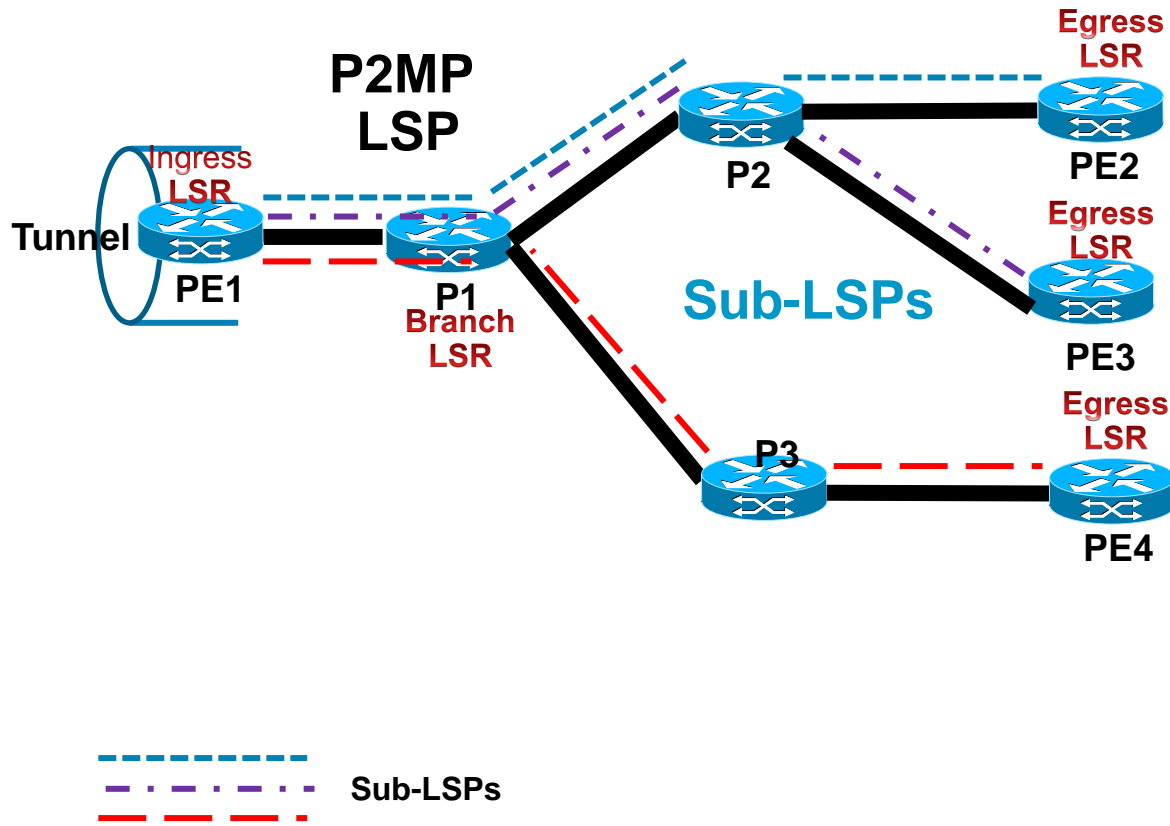

P2MP: Sub-LSPs Rejoin - Crossover

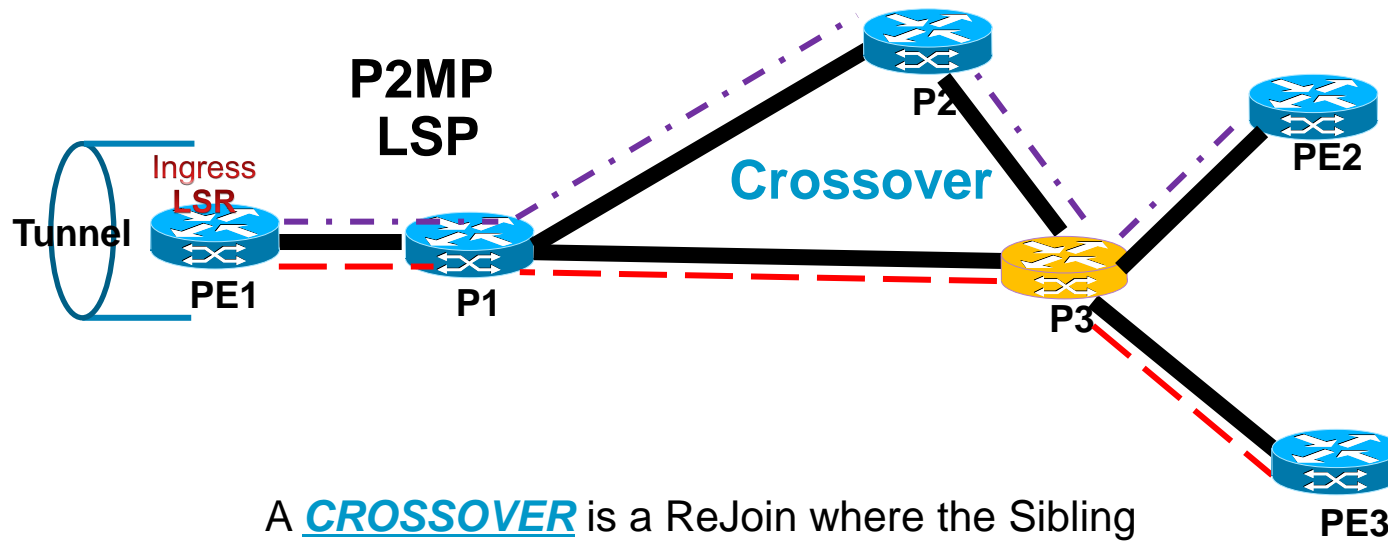

A **CROSSOVER** is a ReJoin where the Sibling Sub-LSPs are going out onto two different streams

 Sub-LSPs

P2MP TE : Sub-LSPs Rejoin - ReMerge

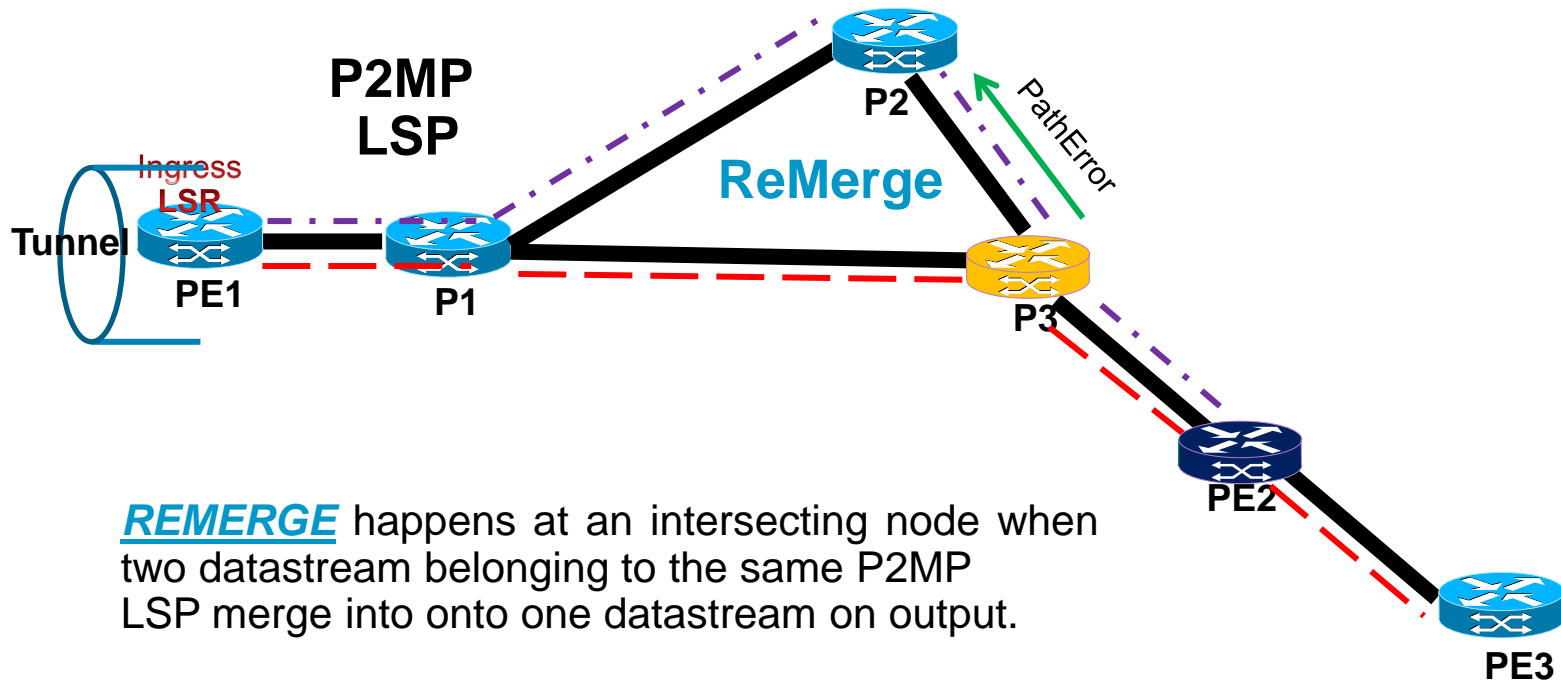

P2MP TE: Sub-LSP Operation - Grafting

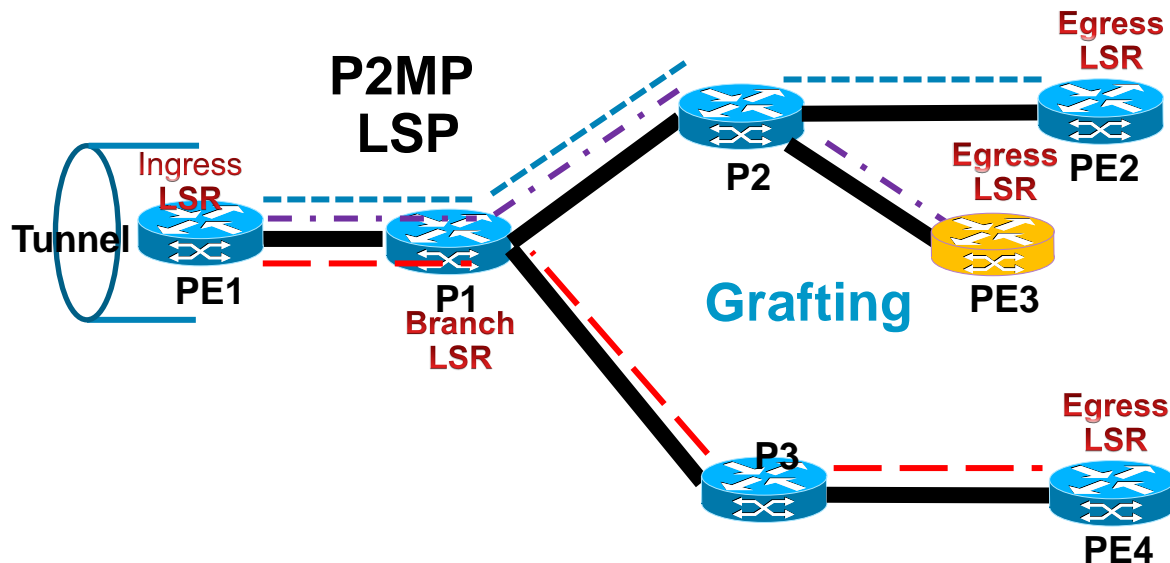

GRAFTING happens when a new Egress is added to an existing P2MP LSP. i.e., a new Sub-LSP (New SubGroup ID, New DST) is signaled with a new destination for an existing P2MP LSP (Same LSP ID)

P2MP TE: Sub-LSP Operation - Pruning

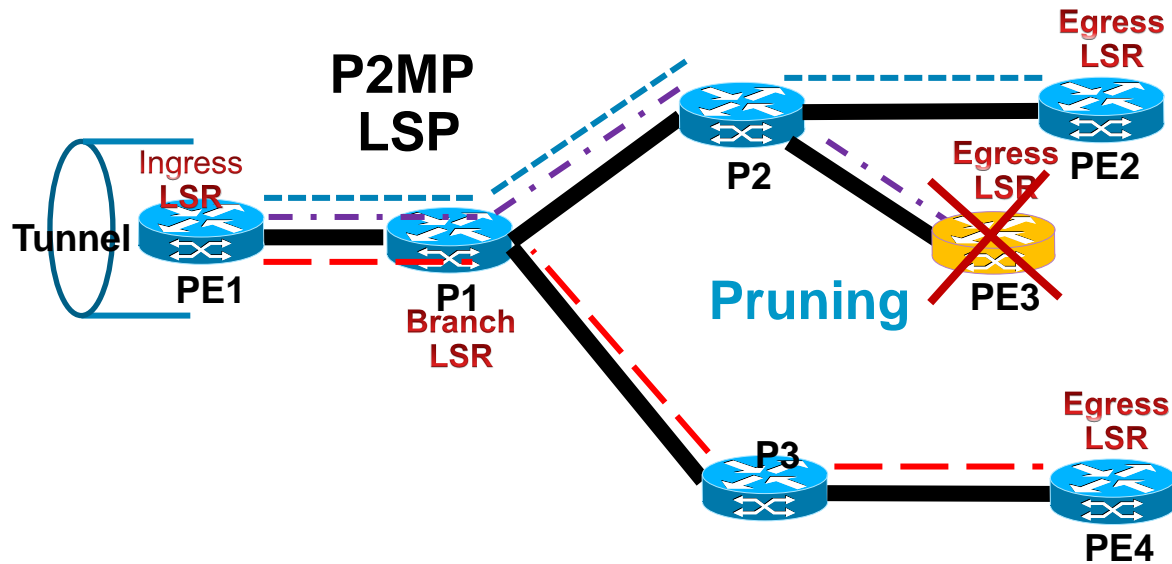

The operation of removing Egress LSRs from an existing P2MP LSP is termed **PRUNING**

P2MP TE: Signaling

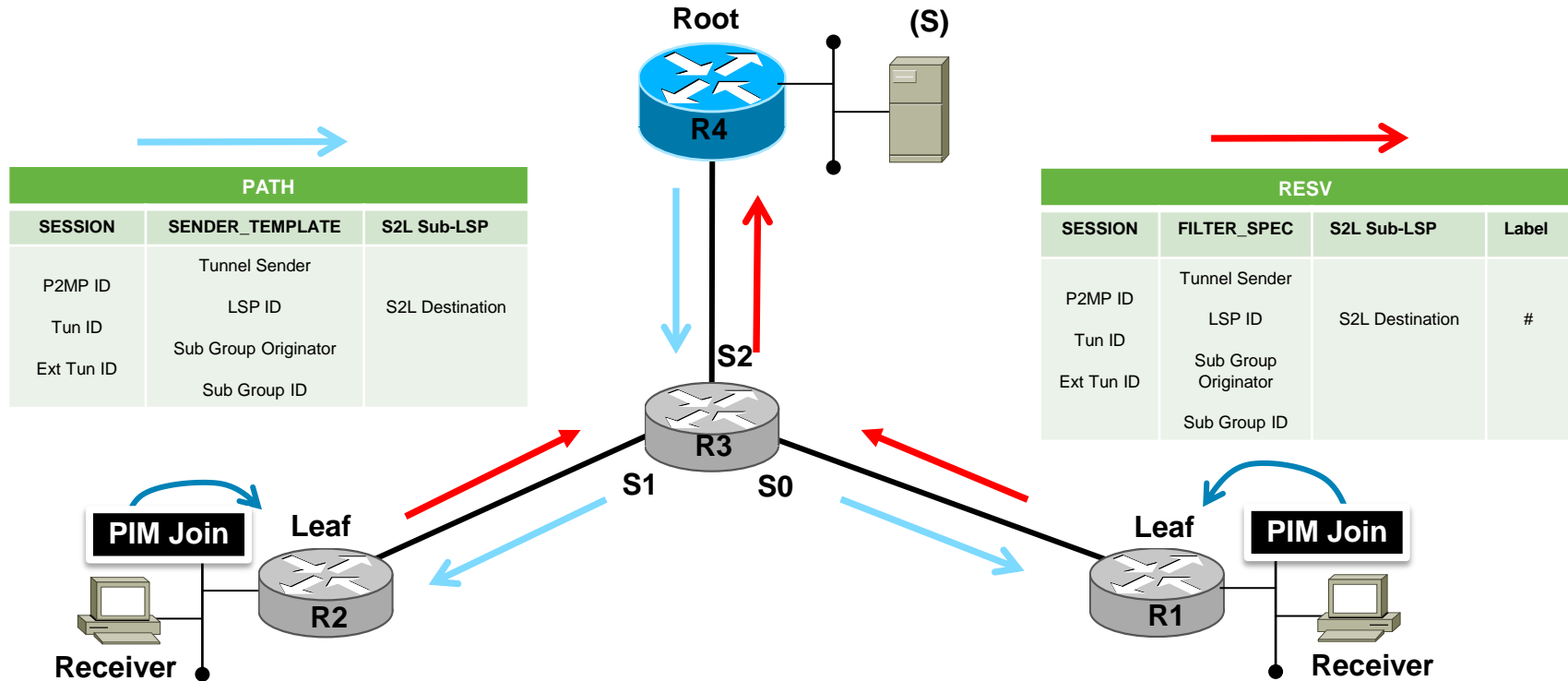

P2MP TE: Signaling

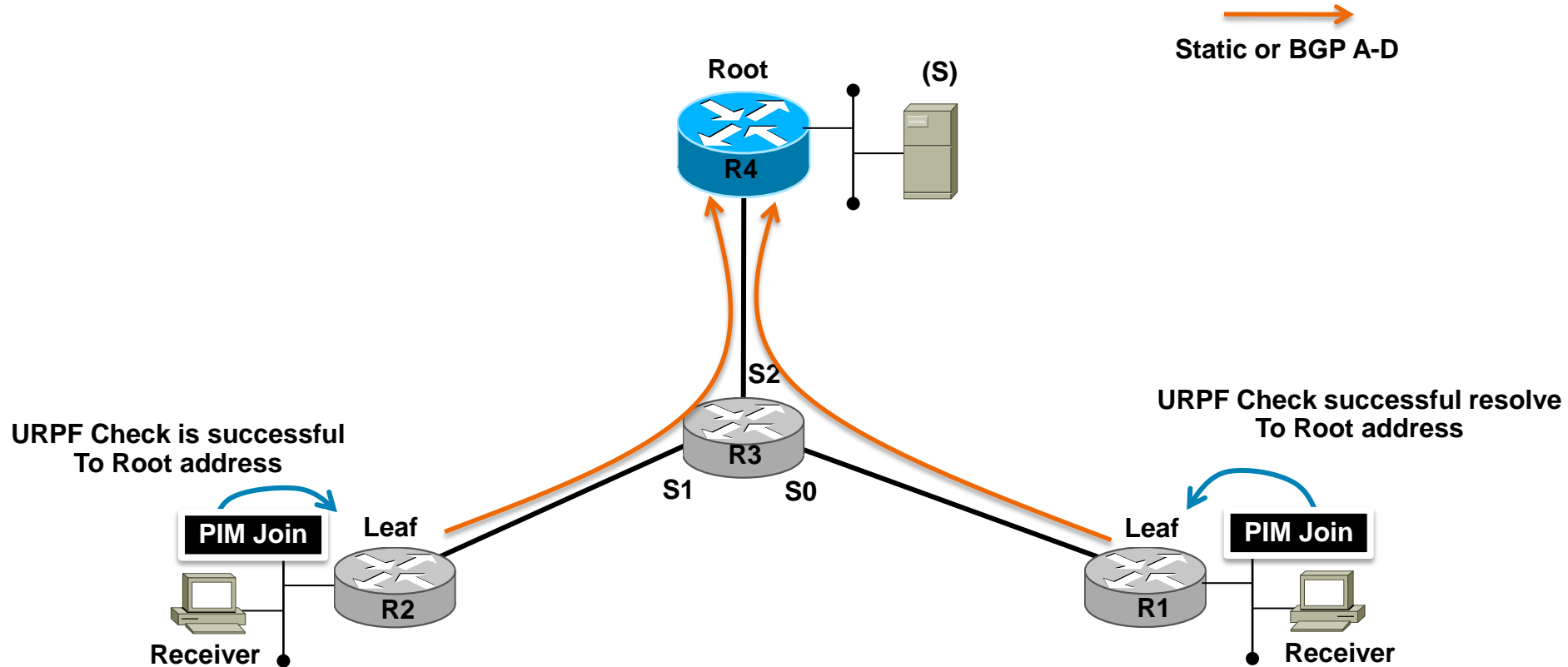

LSM Applications

LSM Control Plane - Recap

- mLDP
 - Is set of extensions to LDP
 - Control messages over UDP/TCP 646
 - **Build P2MP & MP2MP LSP**
 - Receiver driven – Built from leaf
 - using IGP
 - **No periodic Signaling**

LSM Control Plane - Recap

- RSVP-TE

- Control messages over IP 46
- **Build P2MP LSP**
- MP emulated by xP2MP LSPs
- Source-Driven – Head-end to Receivers
- **Periodic Signaling – RSVP Path/Resv**
- **Constrain based routing – Bandwidth/Link affinity/Explicit Paths**

FRR for Traffic Protection

- mLDP also supports FRR using RSVP TE unicast link protection
- Technology allows FRR protection on a per core tree basis for MLDP
- RSVP-TE P2MP supports FRR using unicast link protection
- Ability to choose what type of traffic to go to the backup link
- mLDP has make before break to minimize traffic loss during tree/root node convergence
- RSVP-TE P2MP has make before break during reoptimization events

LSM Application Mapping

Application	Characteristics	LSP Requirement	RFC Drafts
PIM SSM Transit	Dynamic tree building with source to any receiver	P2MP LSP with receiver able to join and leave a tree	draft-ietf-mpls-ldp-p2mp /draft-wijnands-mpls-mlldp-in-band-signaling
IPTV – Multicast	Static tree from few Sources at video Headend to large receivers	P2MP LSP from Video Headend to Aggregation nodes – DSLAM's	draft-ietf-mpls-ldp-p2mp
MVPN Rosen Model	Dynamic tree building with any to any communication	MP2MP LSP for transporting C- Control and data frames P2MP LSP for high bandwidth frames	draft-ietf-l3vpn-2547bis-mcast
Video Transport 1. Contribution 2. Distribution	Carry large bandwidth traffic from 1. studio to studio 2. Media provider to distribution	P2MP LSP for offering loss-less video P2MP LSP with network diversity for high availability	RFC 4875 draft-ietf-mpls-ldp-p2mp

LSM Application Mapping

Application	Characteristics	LSP Requirement	RFC Drafts
Mobile Backhaul for Clock Sync	Distribute clock synchronization from Hub site – RNC/BSC to Cell sides – eNode/Base stations	P2MP LSP with static PW – At layer 2	draft-ietf-l2vpn-vpms-frmwk-requirements
VPLS	Optimal way to handle Broadcast and multicast traffic	MP2MP LSP for handling broadcast P2MP LSP for handling multicast traffic	draft-ietf-l2vpn-vpms-frmwk-requirements draft-martini-pwe3-p2mp-pw RFC 5501
CsC Multicast	Carriers Carrier offering multicast services	MP LSP need to be build within providers BGP Free core	draft-wijnands-mpls-mldp-csc

PIM-SSM Transit

- Supports IPv4 and IPv6 SSM multicast traffic
- Carried across core in P2MP LSP
- Source and Group are encoded into opaque value
 - Signalling of (S, G) state is done in-band
 - Egress PE's for a same multicast stream will generate same FEC
- Source prefixes distributed via BGP
- Root derived from BGP Next-Hop of Source
- Label Mapping message builds tree to root
 - Root is edge router connected to source (injects BGP route)
- PIM is present on the edge of the network

PIM-SSM Transit

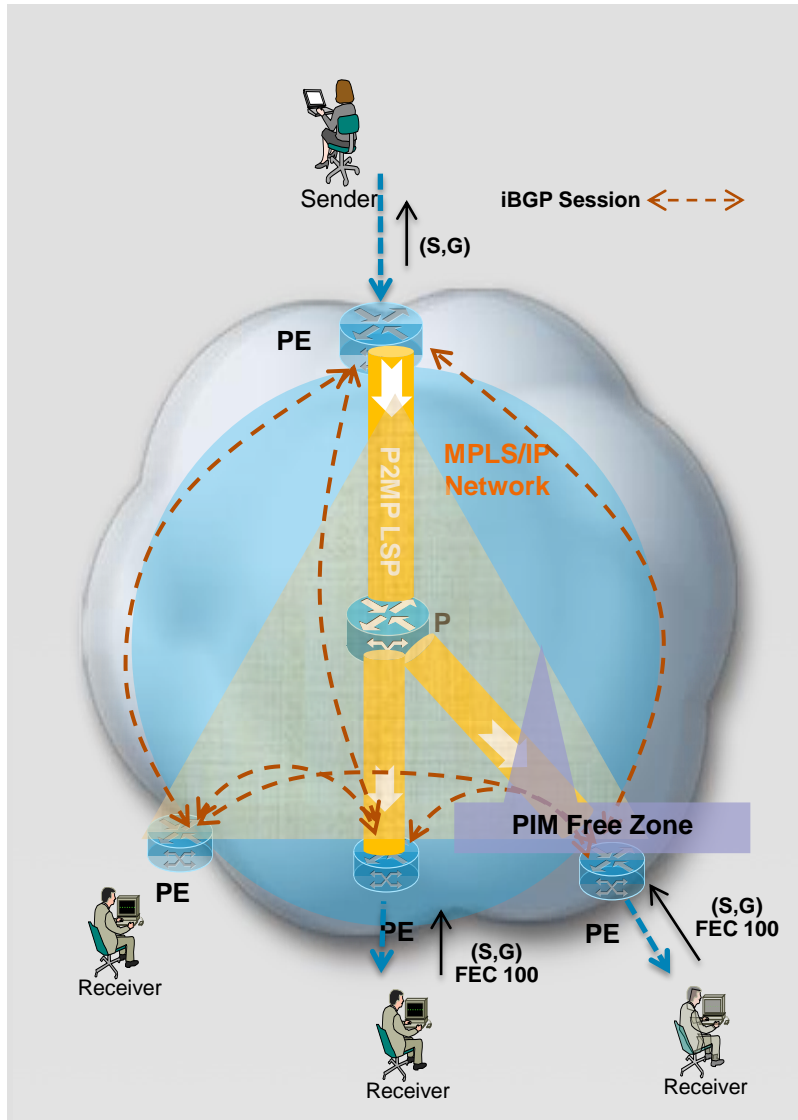

■ PIM-SSM Transit

IPv4/v6 Opaque Value

Source

Group

- One to any Communication requirement
- P2MP LSP allows global PIM-SSM streams to be transported across the MPLS Core – PIM Free core
- Source Prefixes distributed via BGP
- PE Routers need to know the S and G (SSM)
- Receiver Driven – PIM join would trigger a P2MP Down FEC
- Ingress PE pulls the feed
- For IP PIM SM – RP address is used as in place of Source

IPTV Multicast

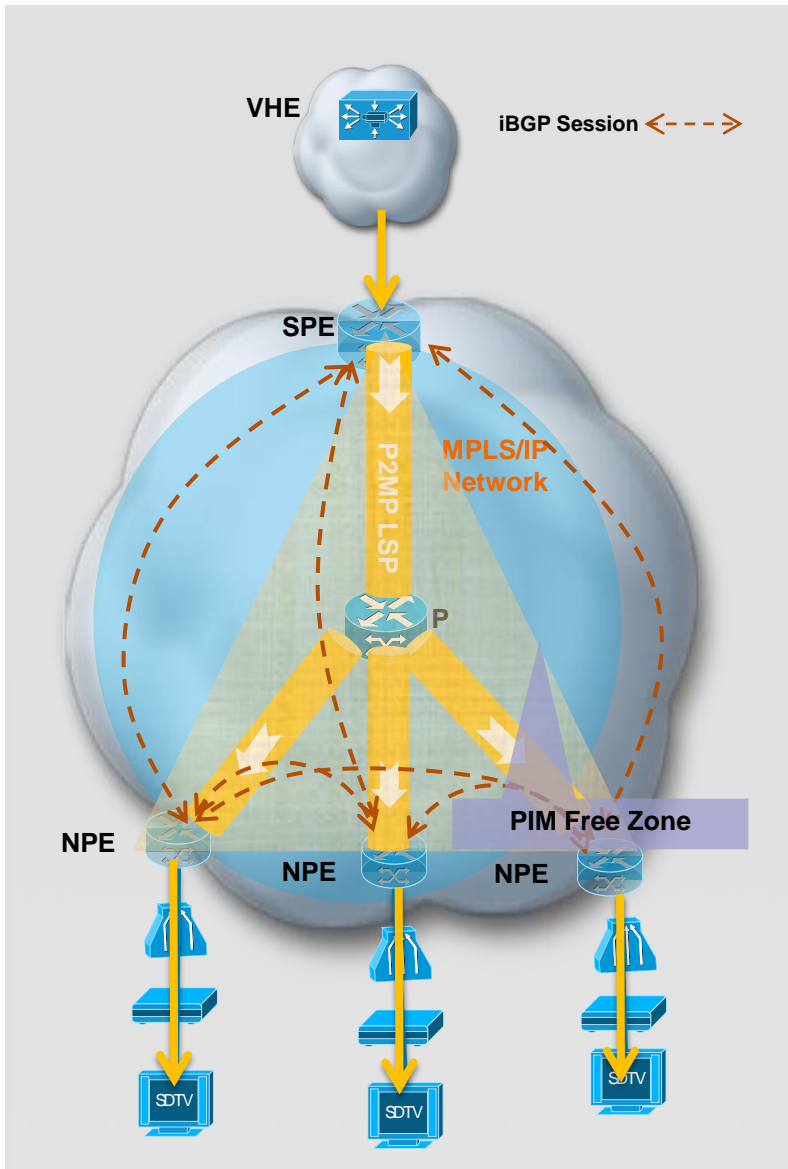

- PIM – SSM Transit

IPv4 Opaque Value	
Source	Group

- S-PE connects to video Head End
- NPE is E-DSLAM aggregation nodes
- One to any communication is required
- P2MP LSP is provisioned between SPE to NPE
- Traffic can be pulled or pushed at S-PE
- Video Source Prefixes distributed via BGP

Multicast VPN over mLDP

- mLDP supports Multicast Distribution Trees (mVPNs)
- mVPN solution is independent of the tunnelling mechanism
 - PIM with GRE encapsulation (Native Multicast)
 - mLDP with MPLS encapsulation
- Default-MDT uses MP2MP LSPs
 - Supports low bandwidth and control traffic between VRFs
- Data-MDT uses P2MP LSPs
 - Supports single high bandwidth source stream from a VRF
- All other operation of the mVPN remains the same
 - PIM neighbors in VRF seen across LSP-VIF
 - VPN multicast state signalling via PIM
- VPN-ID is used in place of MDT Multicast Group address

Multicast VPN over mLDP

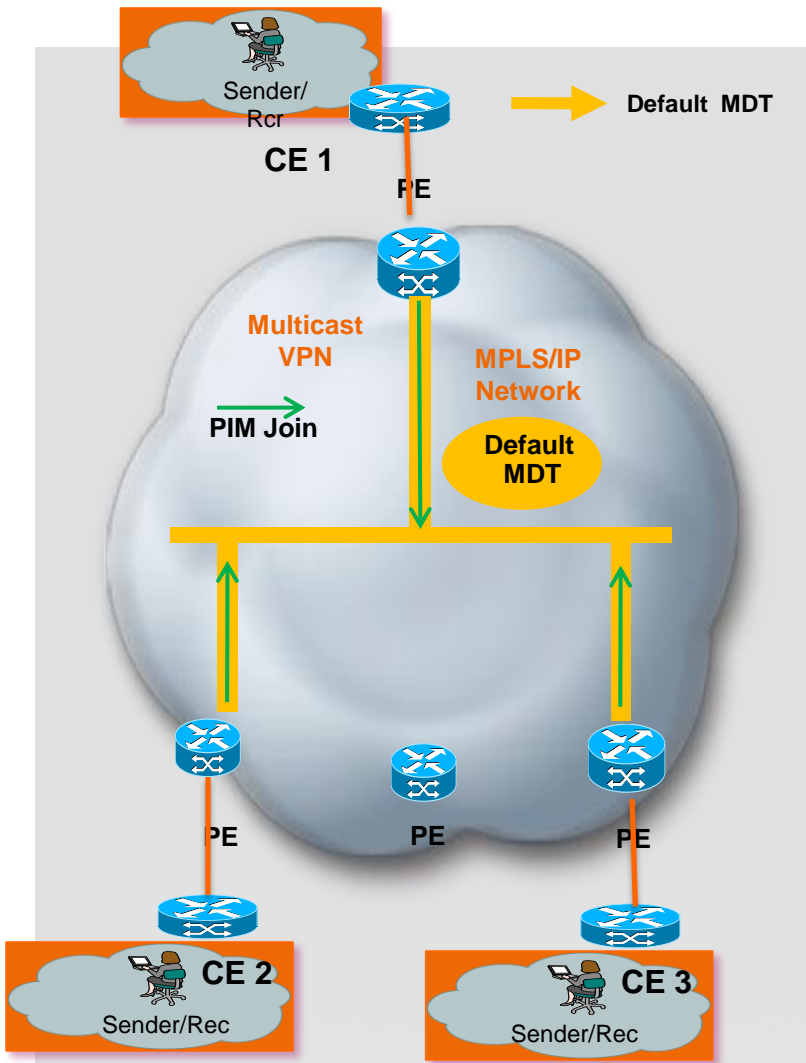

Default-MDT

MDT Opaque Value

VPN-ID	MDT# = 0
--------	----------

- Applications require Any to Any Communication
- Customer CE Devices joins the MPLS-Core through Provider's PE Devices
- The MPLS Core forms a Default-MDT for a given customer
- The Opaque Value used to signal a Default MDT
- It has two parameters:
 - ✓ VPN-ID
 - ✓ MDT number
- MVPN associates an interface for head and tail-end on the MP2MP LSP (just like a Tunnel interface).

Multicast VPN over mLDP

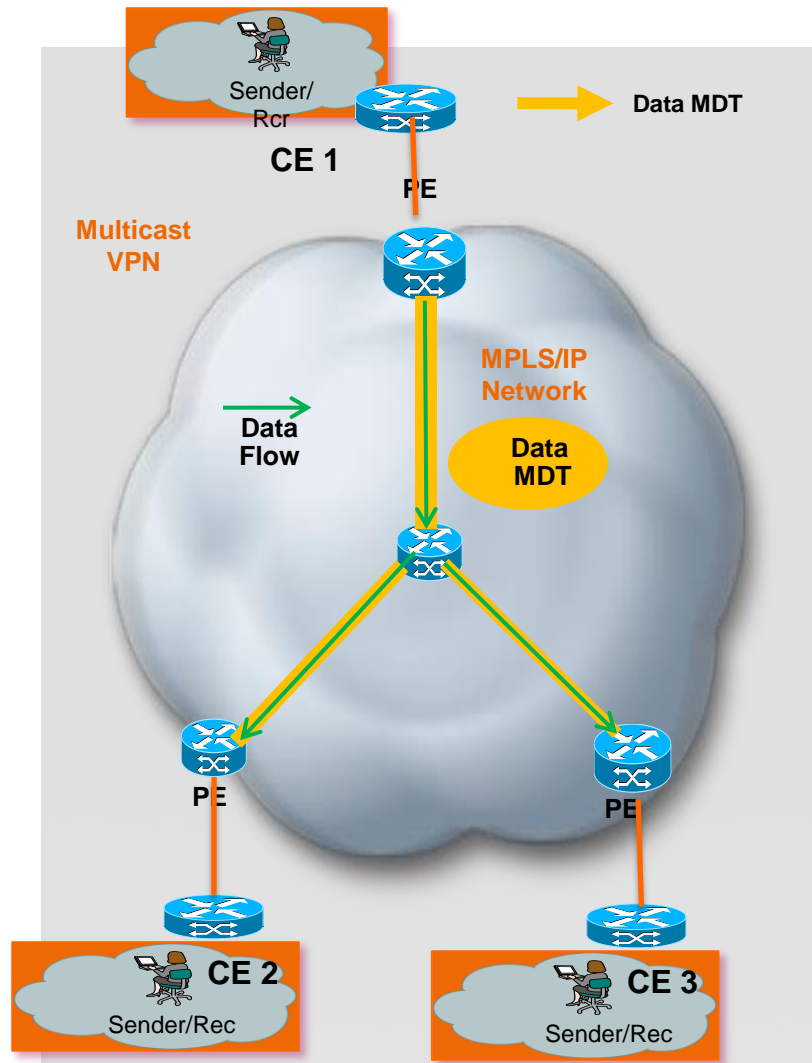

■ Data-MDT

MDT Opaque Value

VPN-ID	MDT# > 0
--------	----------

- One to many Application
- Optionally a Data-MDT can be built based on traffic thresholds on sending PE when high BW source appears in the customer network.
- Data-MDT uses P2MP LSPs to support high BW (S,G) Stream
- Data-MDTs built for (S,G) in the mVPN
- The Opaque value is used to signal Data-MDT
 - ✓ VPN-ID
 - ✓ MDT #
 - ✓ (S,G)

P2MP TE for Video Transport Provider

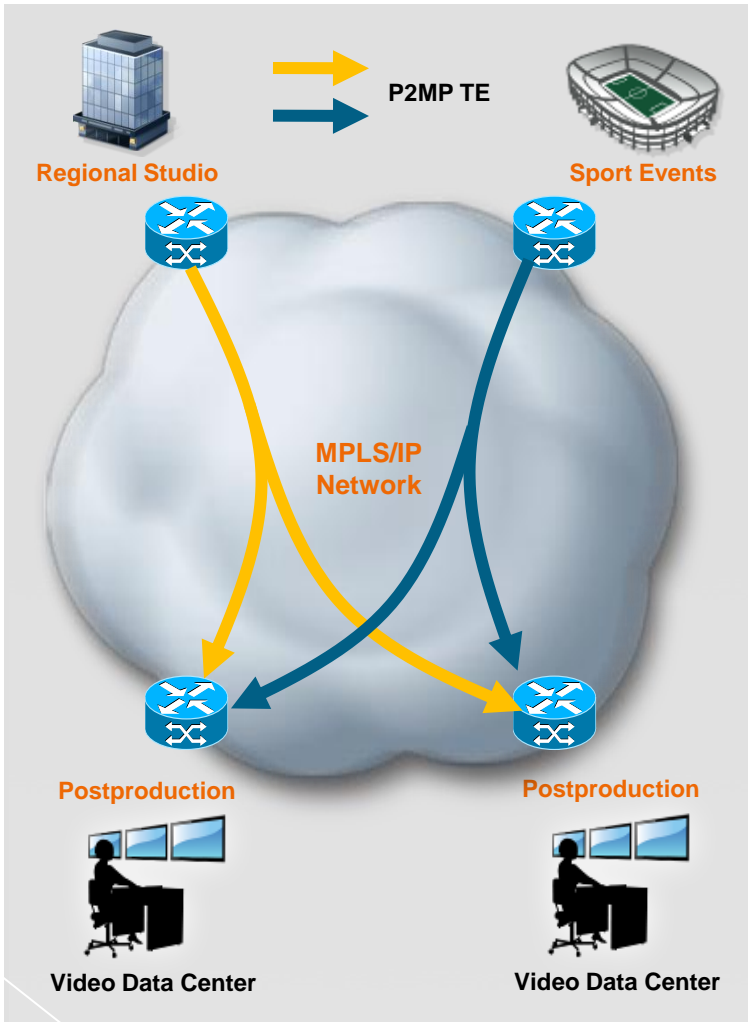

Typical Users:

- Broadcasters
- Content distribution providers

Deployment Requirements:

- Bandwidth management
- Explicit networks paths
- P2MP traffic distribution
- Network failure protection

LSM Application:

- Constrained-based P2MP TE tunnels (explicit paths, BW)
- TE FRR for link protection

Video Contribution Network

An typical P2MP TE Deployment for the Video distribution

Two Methods to push the Video

1. Push the replication as close to the receivers as possible
2. Two LSPs in the core with active and back up role – Spatial Diversity

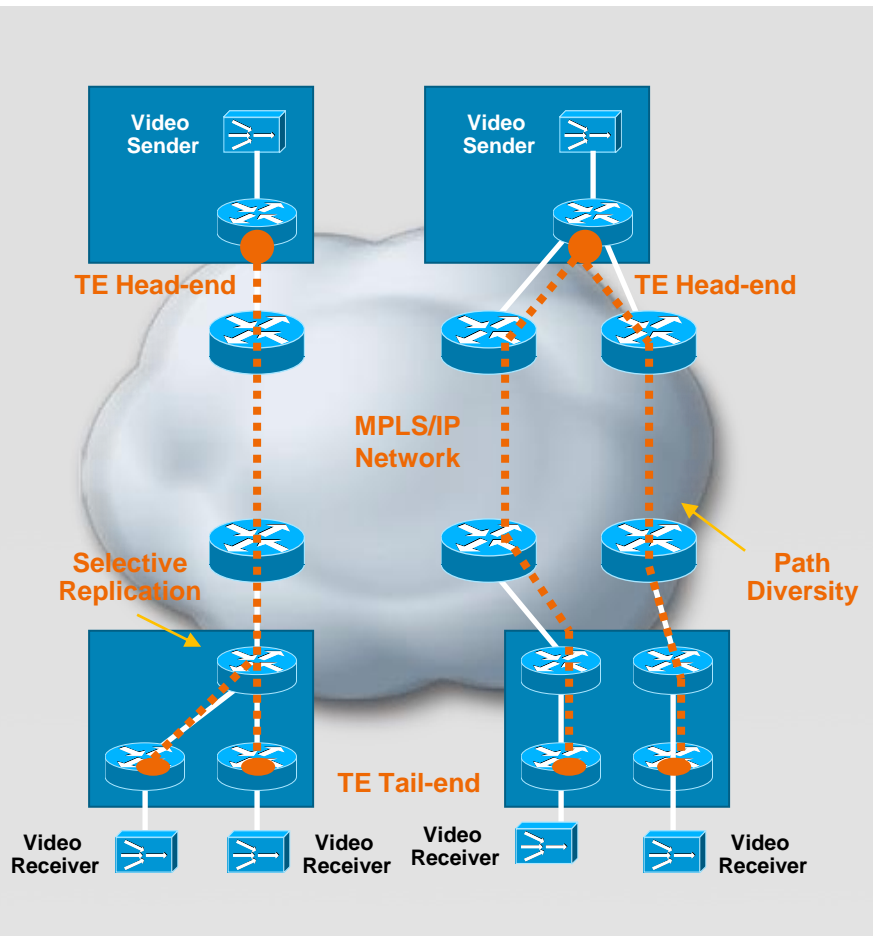

Video Service Offering P2MP-TE for Shared Egress

Live-Live with Spatial Diversity

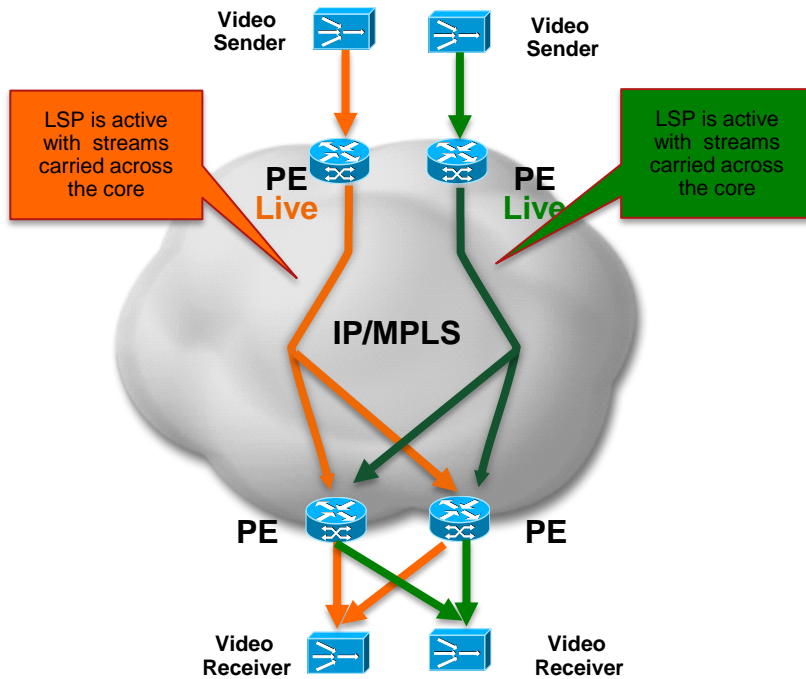

Live-standby with Spatial Diversity

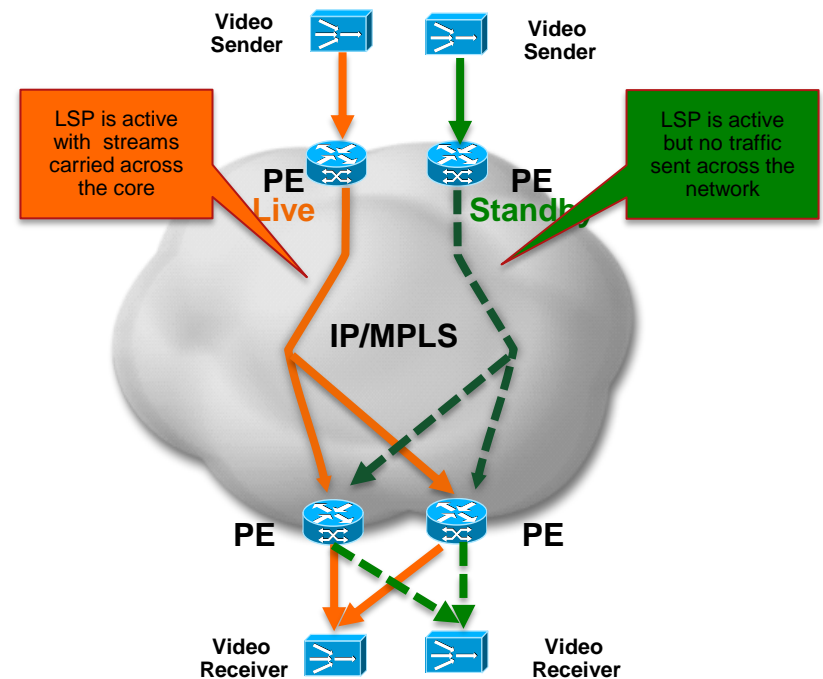

Video Service Offering P2MP-TE for Dedicated PE

Live-Live with Spatial Diversity

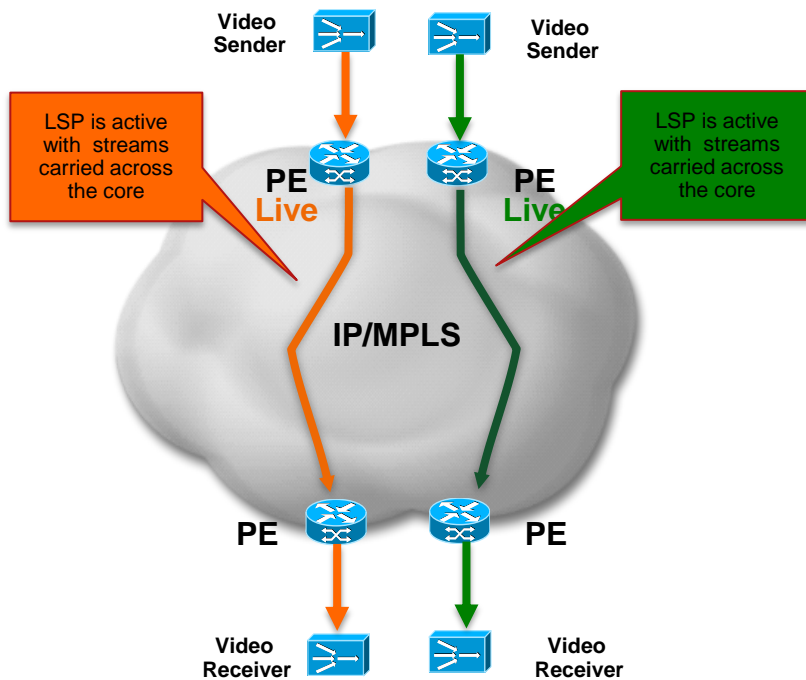

Live-standby with Spatial Diversity

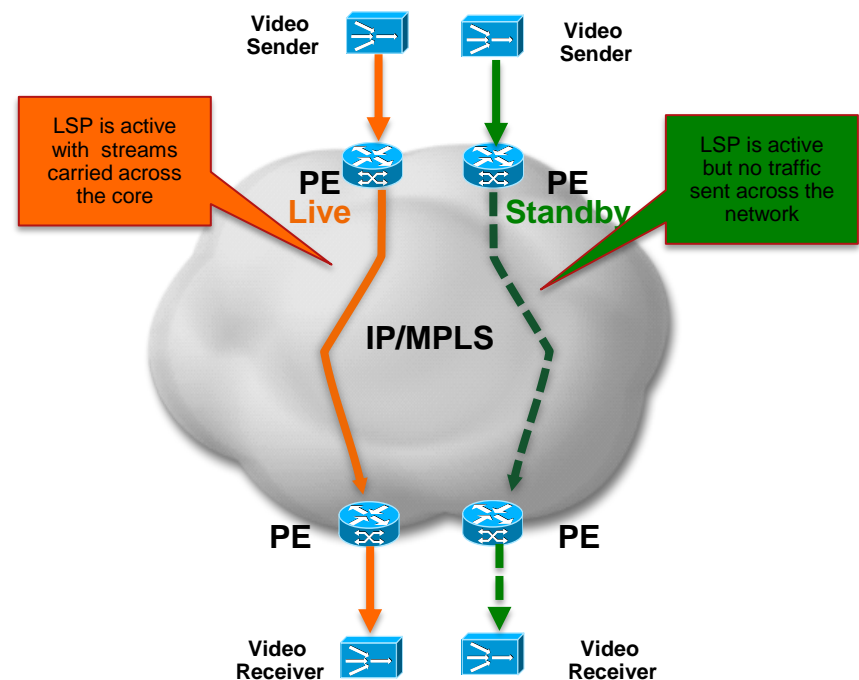

Video Service Offering using P2MP-TE LSP

Live-Live

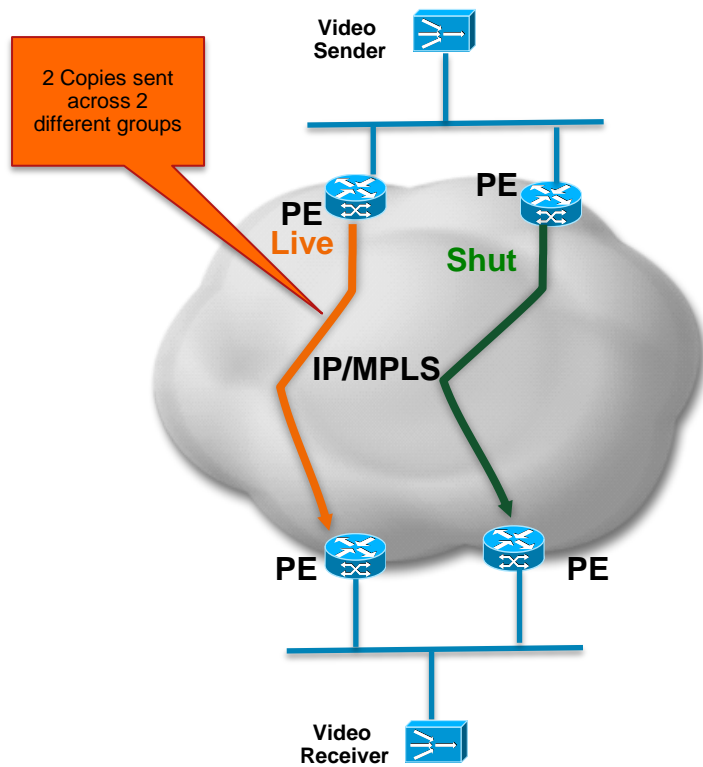

Live - standby

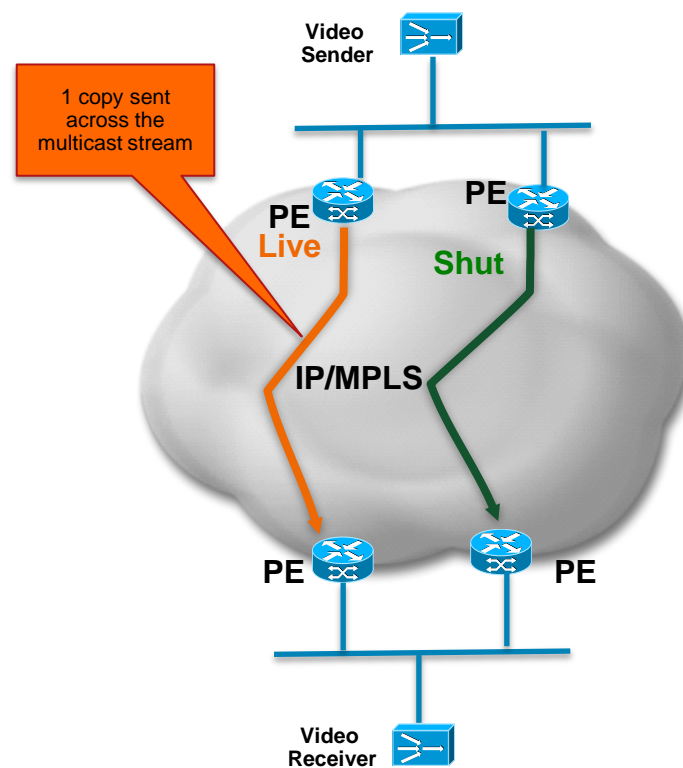

IP RAN Mobile Backhaul

- Mobile Operators looking at Carrier E to meet increasing bandwidth requirements and reduce Opex
- Failure to synchronize the primary reference clock by base stations can effect voice and data services
- Sync can be made independent on physical layer by relaying on layer 2 /3 packets being tunneled
- Mapping of layer 2 multicast traffic to P2MP LSP is static

IP RAN Clock Sync – P2MP Static PW

- Reference clock is distributed via P2MP Static PW between the Base station to PRC –via 1588v2¹
- Mapping of layer 2 multicast traffic to P2MP LSP is static

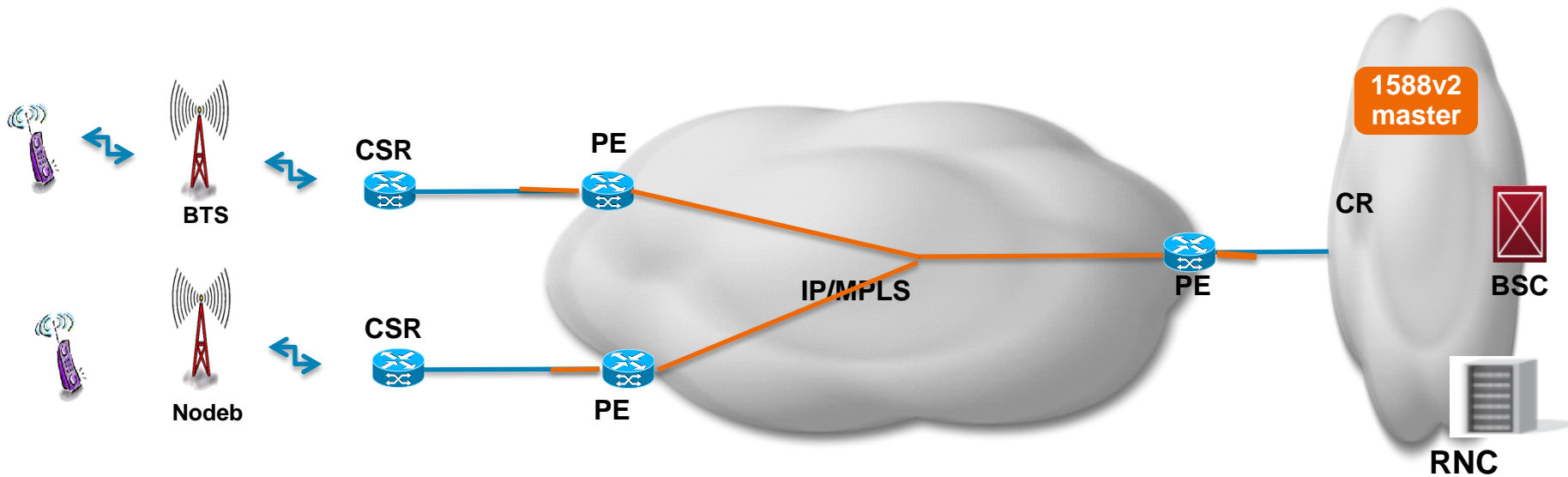

Note: Radio vendor should support recovery from 1588

LSM Case Study

P2MP-TE for Video Transport - Motivation

- Build converged core to transport media Video and Data services
- RSVP-TE based P2MP the protocol of choice
 - Allows Bandwidth constrain to map to Broadcast TV (Streamer rate) – Full time, Occasional use
 - Avoids over subscription and thereby congestion
 - Allows true spatial diversity via link Coloring
 - Can utilize RSVP-TE FRR and provide sub-50ms link protection

Enhanced Service Offering -

- Support flavors of services for media transport
 - Live-Live Loss-Less with/out spatial diversity
 - Live-Standby with with/without spatial diversity
- Provider providing Transport of IP based packetized compressed HD/SD Video feeds over terrestrial links
- Bandwidth planning critical to video flows
 - No oversubscription allowed on links

Loss less video – Live Live Offering

- Traffic flow from collection facility to remote satellite uplink facility
- For Live-Live –
 - 2 Copy of same stream sent in 2 different Unique devices and Paths
 - Stream merged by encoder/ASI device

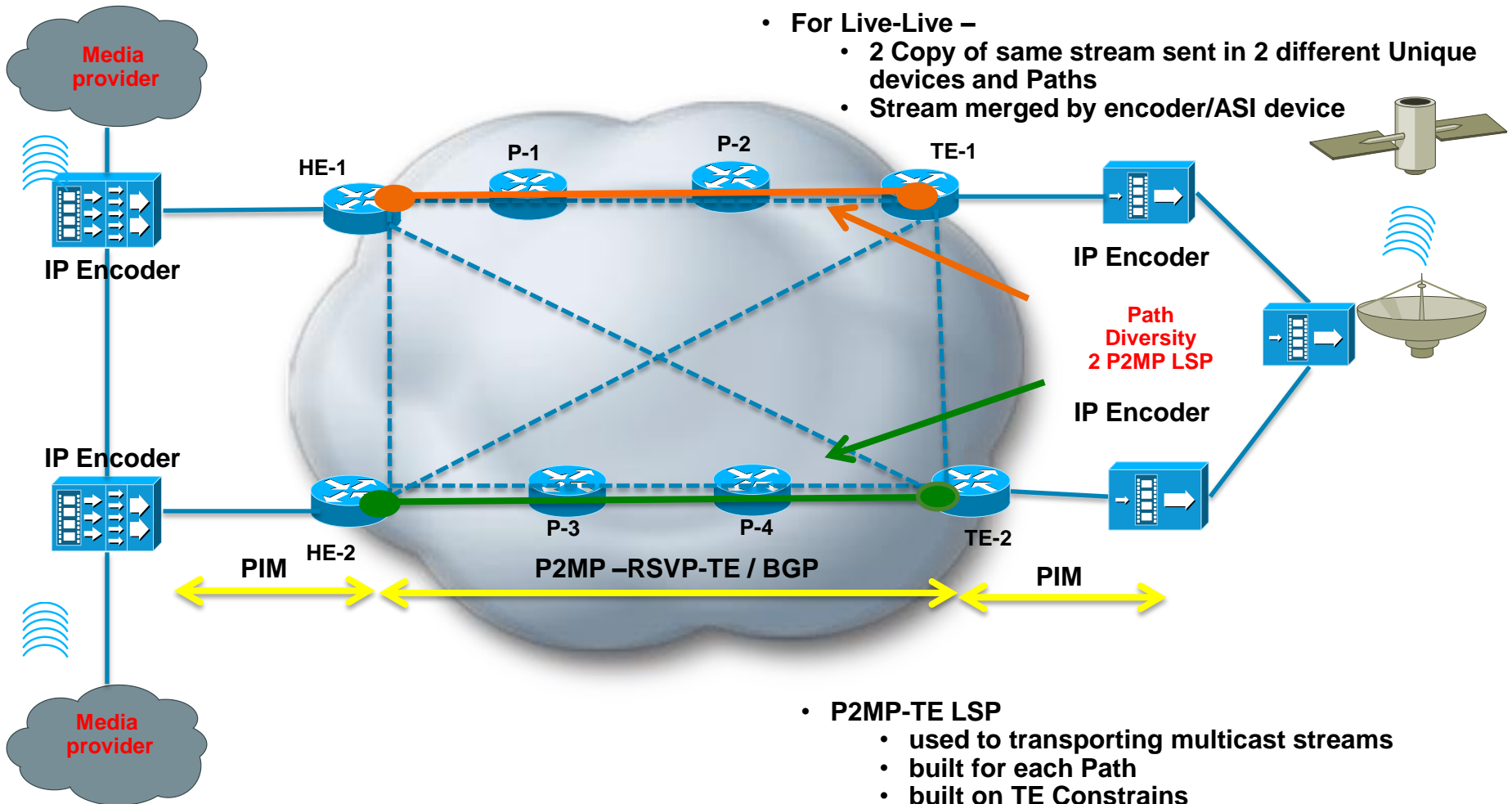

- P2MP-TE LSP
 - used to transporting multicast streams
 - built for each Path
 - built on TE Constrains

Live Standby – 1 Copy Offering

- Traffic flow from collection facility to remote satellite uplink facility
- For Live-Standby-
 - 1 Copy of same stream sent in provider network
 - Standby copy sent on primary node failure
 - Manually triggered / Automatic - Optional

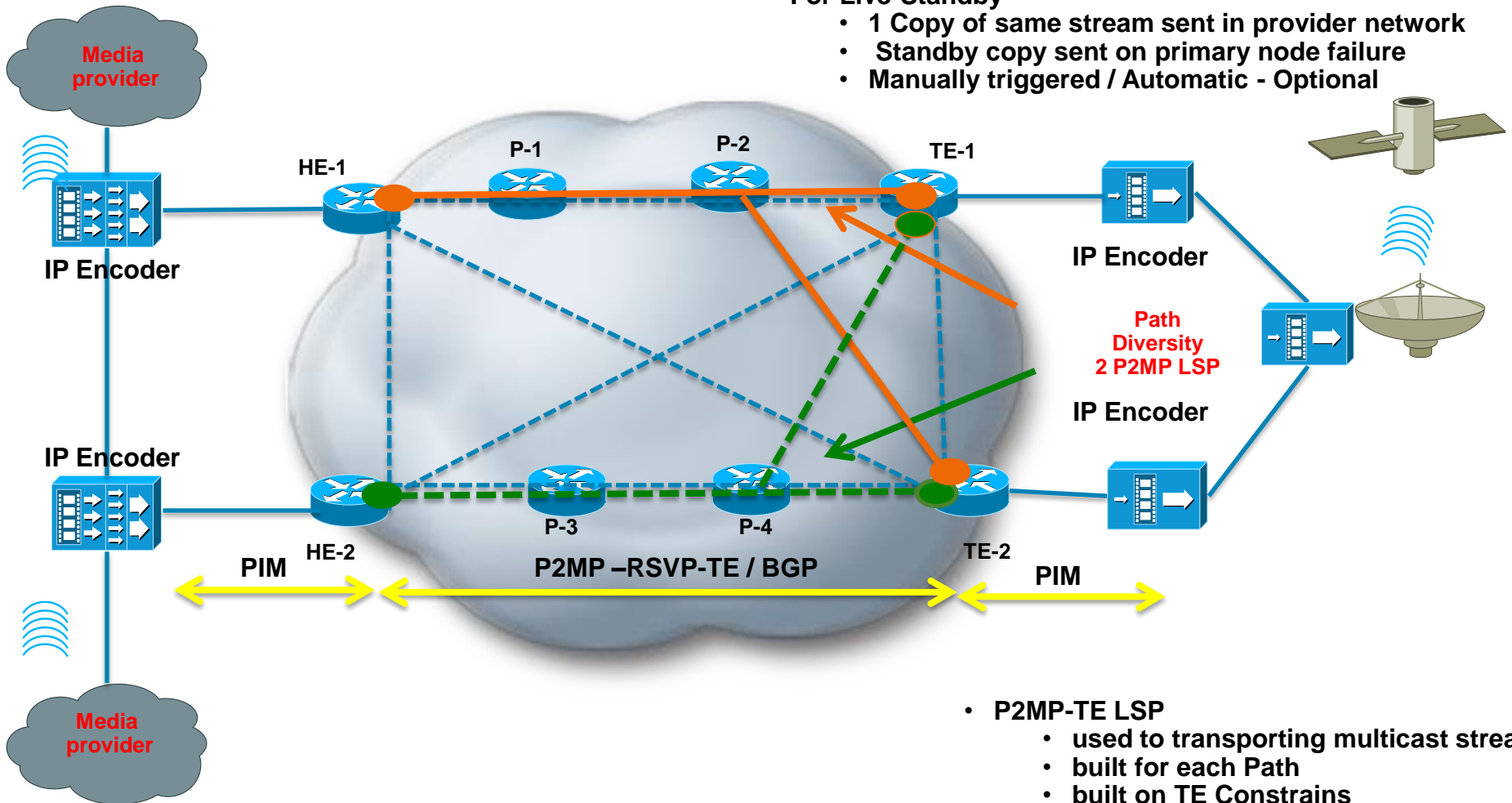

- P2MP-TE LSP
 - used to transporting multicast streams
 - built for each Path
 - built on TE Constrains

mLDP - Motivation

- Increase in multicast adoption by VPN customers led to increase in states – (*,G), (S,G) state in core for Data Tree
- Remove PIM from the core
 - Reduce signaling overhead coming from PIM in the P-Core instance
- Use 1 common encapsulation type within the provider core
 - MPLS - Unicast/Multicast traffic
- mLDP the protocol of choice
 - Reduce signaling overhead
 - Support RSVP-TE FRR for link protection

Topology – 2547 Provider with Rosen Model with IP/GRE Encap

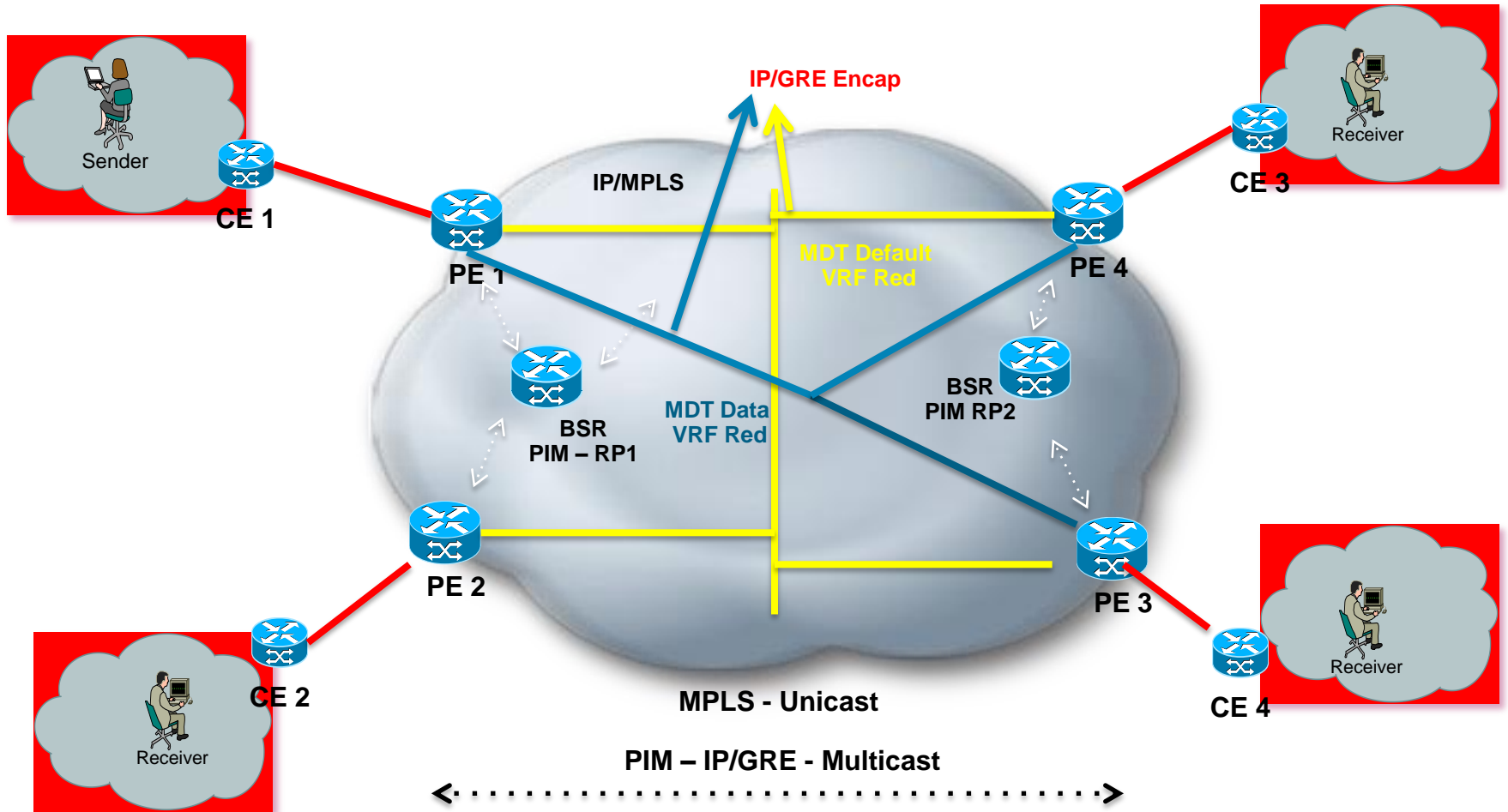

Topology – 2547 Provider with Rosen Model with mLDP

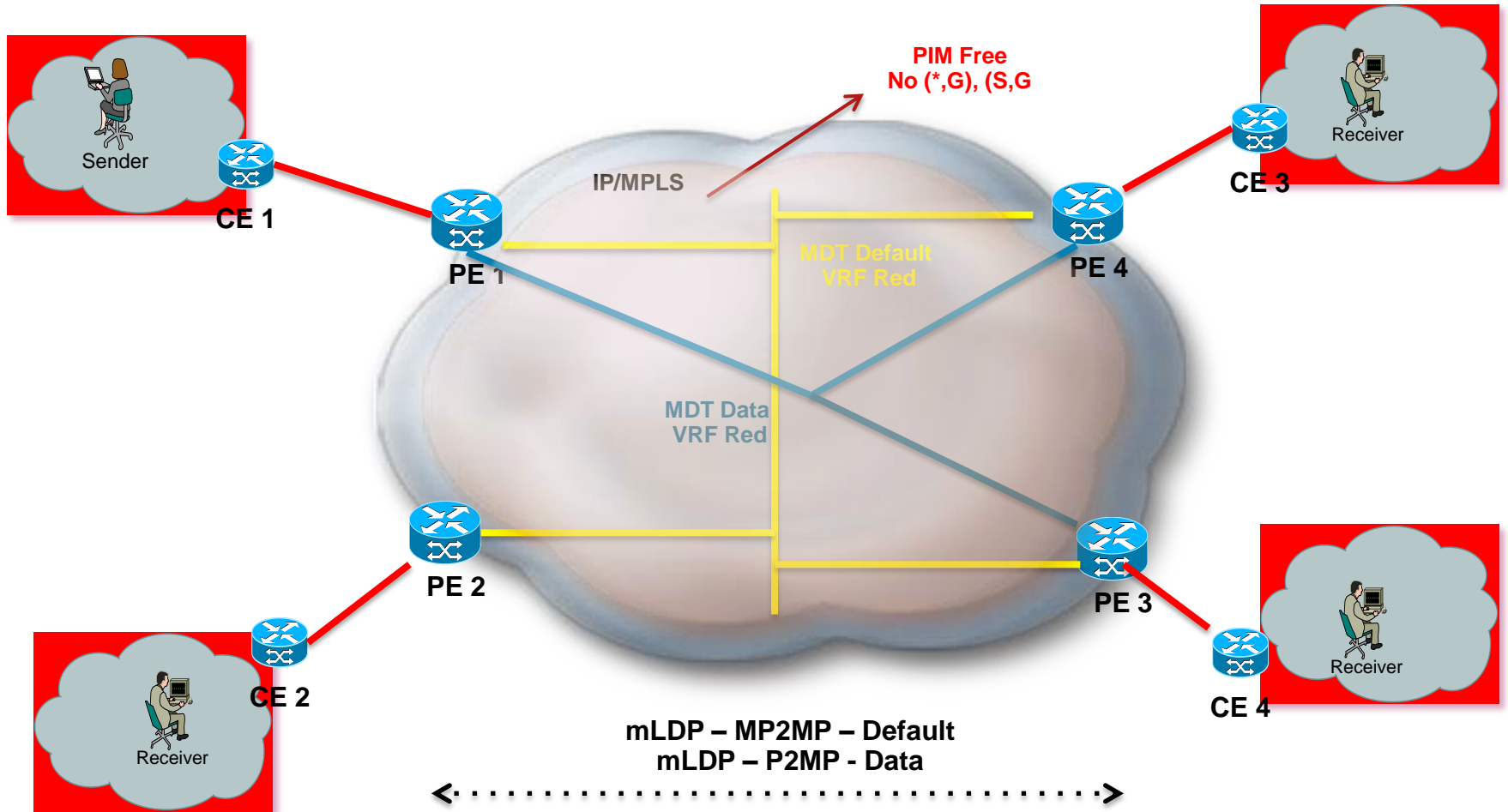

1. Proper Planning for placement of root for MP LSP for default MDT
2. Ingress PE to source considered as Root for Data MDT

MVPN – LSM Migration

- Migration of Provider (PMSI) Multicast Service Instance (P-Instance) from
 - PIM*GRE to MLDP – MVPN
- Build PMSI instance with MLDP along with existing PIM instance in core
- PIM Neighborhood are maintained across PE via both GRE Tunnel and LSP Interface
- Move traffic flow on per vrf basics from GRE to mLDP
- Remove tunnel specific config on successful migration of VRF

Migration Methods - MVPN

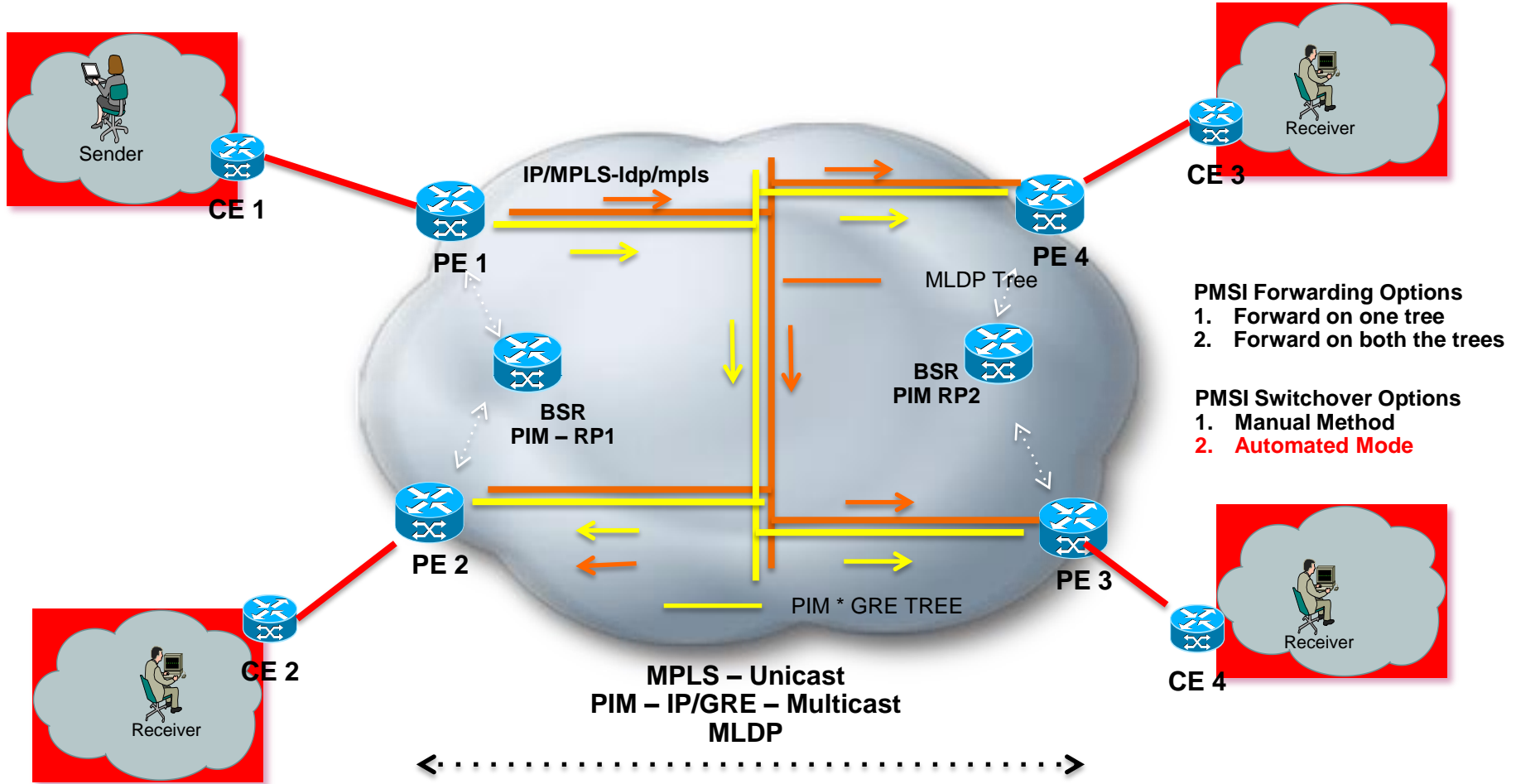

LSM Deployment Consideration

LSM Protocol Selection

- LDP or RSVP-TE commonly used to build the MPLS infrastructure
- Each protocol has its pros and cons
- MLDP and P2MP TE can coexist

LSM Comparison

LSM Feature	MLDP	P2MP – RSVP-TE
Tree Building	Receiver driven – Dynamic tree building	Deterministic bandwidth guarantee for the tree – Headend based tree
Fail over protection	FRR is optional Capability	FRR in tree step-up
Applications	Suitable of any applications with any source/receiver	Suitable for few applications with limited and static sources – Broadcast TV where BW requirements exist.

LSP Application

- MP2MP LSP
- Any to Any traffic
- Allows leafs to send traffic
- Multi-access segment across PE
 - Default MDT
 - VPLS Broadcast
 - PIM PIM-Bidir Traffic

- P2MP LSP
- One to many traffic
- Useful for Source to receiver traffic
 - Transit PIM SSM
 - Data-MDT
 - Video Transport

Signaling Considerations

Plan for scaling from Signaling overhead

An SP With 100 Sites

1. **MP2MP LSP** - PE – has 1 MP2MP Control plane and 1 P2MP Data plane
2. **P2MP LSP** – PE has 1 P2MP Control Plane and 1 P2MP Data Plane

With core each PE exchanges 1 control message per neighbor – in this scenario around 100

An SP with 100 sites

1. **MP2MP TE LSP**– PE – builds 99 S2F Control planes for 1 P2MP Data plane
2. **P2MP-TE LSP** – PE – Builds 99 S2L control planes for 1 P2MP Data Plane

Within core there are around 9900 S2L control messages

Note: Application requirements will weigh in for protocol selection

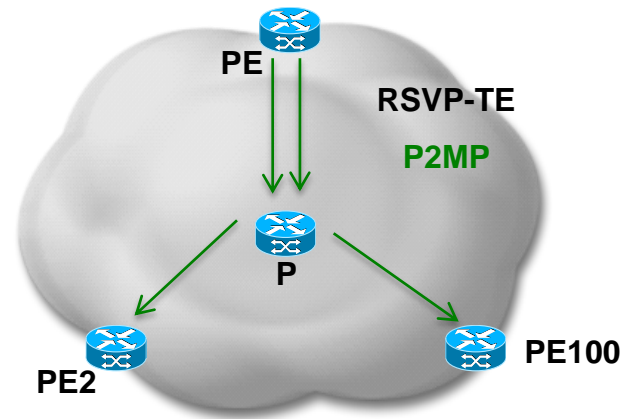
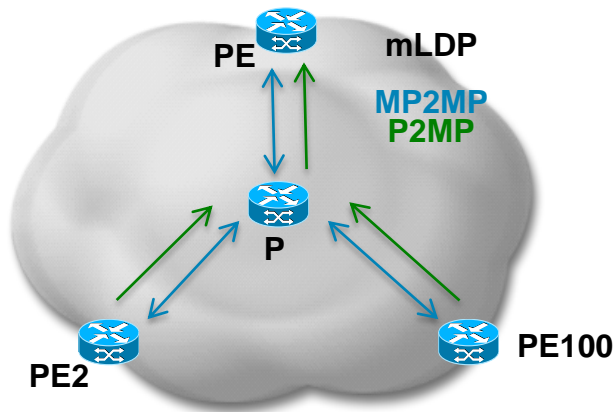

Deployment Selections -

- Path diversity for a given flow
- Bandwidth Guarantee Video stream
- Limited set of sources and fairly static
Receivers may vary
- Preemption of channels

Summary

- Label switch Multicast is about transporting multicast frames with MPLS encapsulation
- Both RSVP and LDP with extensions protocols may be used to build the LSM infrastructure
- P2MP-TE, mLDP can co-exist with LDP, RSVP-TE
- Application, scaling and feature requirements determine the protocol selection
- Typical LSM Applications are for mVPN, PIM SSM Transit, Provider Video Contribution & Distribution

Questions



Backup slides

Video Transport Provider – Background

- Video Transport provider involved in distribution of content
 - Pre production content across production houses/studios
 - Content distribution in primary and secondary space
 - Bandwidth requirement per feeds vary from 4M to 20m
- Video Provider involved in the distribution of Data Content
 - Internet streaming
 - Pay per view channels
- Media Data and content are offered over different backbone network

mLDP - 2547bis VPN Provider

- Service Provider with IP/MPLS backbone with around 200 VPN end points
- mVPN service offered in multi-vendor environment using Rosen Model
 - IP/GRE encapsulation
 - BSR with PIM-RP used in PMSI
- Default-MDT used for C-control Packet and low bandwidth flows
- Data-MDT used for High Bandwidth flows
- Multicast application are moderate bandwidth application with one to many flows

MVPN Comparison

PIM & Rosen (GRE)	P2MP-RSVP-TE	MLDP
Rosen support on Edge – PE device	Edge and Core need to support	Edge and Core need to support
Periodic Updates	Periodic updates	Non Periodic Updates
P2MP & MP2MP	P2MP support only	P2MP & MP2MP
Receiver based dynamic computed tree – PIM or BGP	Deterministic Headend based tree - BW Guarantee	Receiver based dynamic computed tree – PIM
MoFRR supports fast convergence in core	FRR provides sub-50ms convergence	FRR provides sub-50ms convergence
Scaling – As scale increases – increasing numbers of state has to be maintained	Scaling – Signaling overhead needs to be considered	Can scale higher due to non-periodic updates